



IRON SIDE

# ELECTRICAL & AUTOMATION



Price List Catalogue July 2025

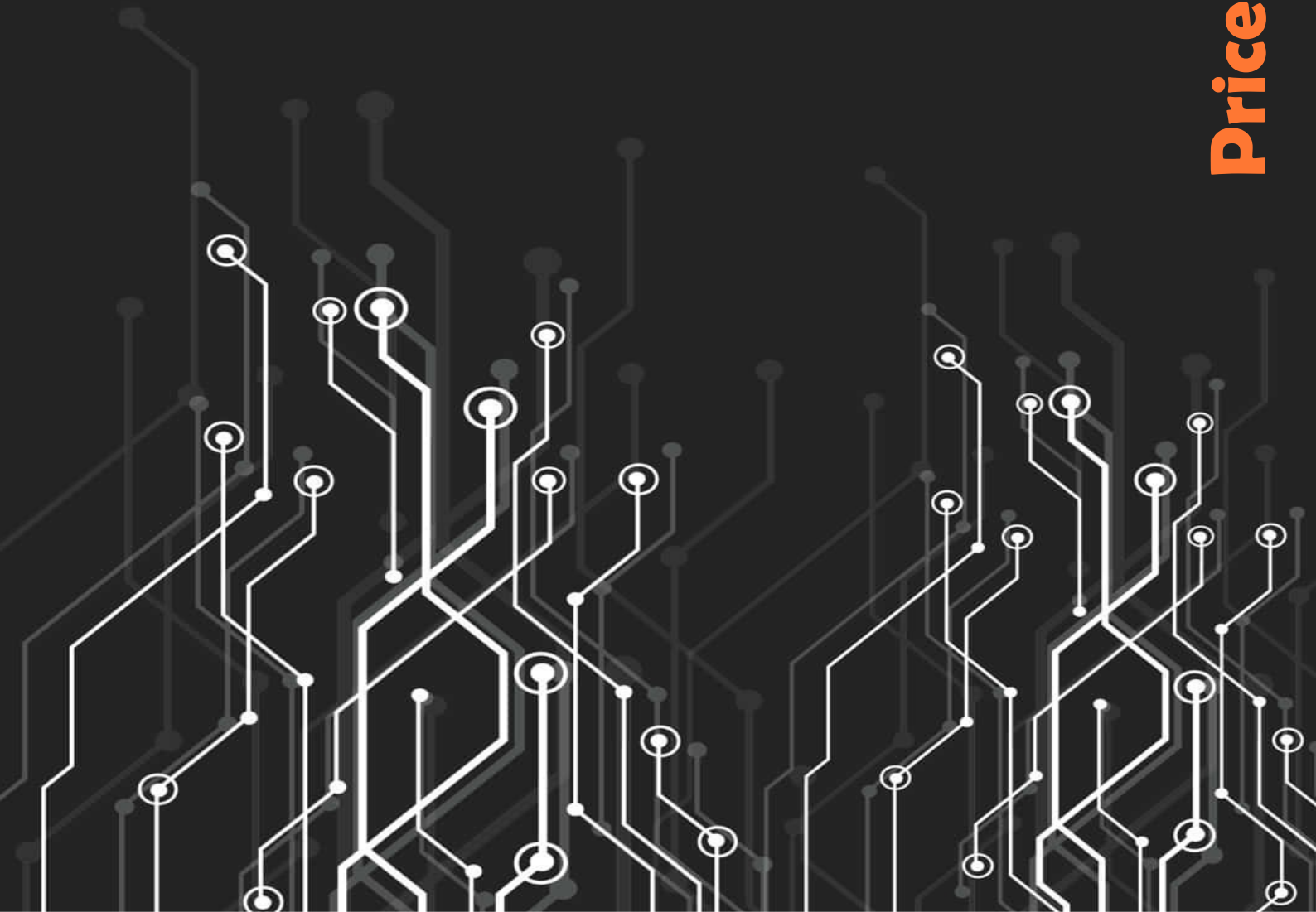

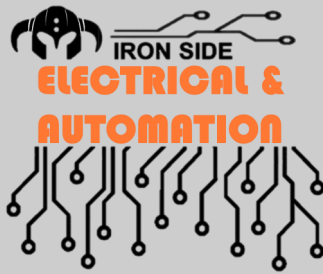

## About Us

Iron Side Electrical & Automation is a proudly South African inland distributor of premium electrical switchgear and automation components. We specialize in supplying dependable, cost-effective solutions to installers, panel builders, system integrators, resellers, and OEMs. Backed by leading global brands and responsive technical support, we are committed to powering your operations with precision, reliability, and performance.

### Official Distributor of ETEK Switchgear

We are the official inland distributor for ETEK, offering an extensive and versatile product range:

- Protection Devices: MCBs, MCCBs, Surge Protection Devices (SPDs), fuses & fuse holders
- Motor Control: MMS, contactors, overload relays, DOL starters, star-delta starters
- Control & Indication: Push buttons, selector switches, pilot lights, illuminated buttons, buzzers, sirens, signal towers, foot switches, pendant controls
- Power Distribution: DB boards, enclosures, changeover switches
- Relay Systems: Plug-in relays and bases
- Cooling Solutions: Panel fans and ventilation systems

### Automation & VSD Solutions

- Official Distributor of M-Driver VSDs – IP20 & IP66 models (AC 220V–415V)
- Official Distributor of Sinee EM760 Heavy-Duty Closed-Loop VSDs – (AC 380V–690V)

### We also supply a range of supporting automation components, including:

- Potentiometers, brake choppers, brake resistors, EMC/RFI filters, input chokes
- Complete VSD PID panels, DOL panels, and Star Delta panels
- Legend plates, DIN rail, MCB busbars
- Timers, temperature controllers, temperature sensors
- Automatic changeover switches and rotary isolators

### Reach & Delivery

Based in Gauteng, Iron Side Electrical & Automation proudly supplies the inland South African market, with nationwide delivery and extended logistical support throughout SADC countries. Whether you're in a major city or a remote site, we ensure fast and efficient delivery to keep your business moving forward.



# INDEX

	Page
ETEK Miniature Circuit Breakers 4.5KA	4
ETEK Miniature Circuit Breakers 6KA	5-6
ETEK Miniature Circuit Breakers 10KA, MCB Accessories, Earth Leakage, Surge Protection Device	7
ETEK Moulded Case Circuit Breakers and Accessories	8-11
ETEK Change Over Switches, Din-rail Mount, Base Mounted and Automatic Type	12
ETEK Modular Contactors	13
ETEK AC Fuse Holder and Fuses, PV Fuse Holders and Fuses, NH Fuse Holders and Fuses	14
ETEK Miniature Contactors and Accessories	15
ETEK DC Contactors and Multi Configuraron Contactors with Accessories	16
ETEK Magnetic Contactor Series and Accessories	17-20
ETEK Thermal Overload Relays	21
ETEK Manual Motor Starters / Motor Protection Circuit Breakers	22
ETEK Direct Online Starters	23
LS Electric Moulded Case Circuit Breakers, Metasol & Susol Series	24-27
LS Electric Air Circuit Breakers and Accessories	28-30
LS Electric Metamec Miniature Contactors, Thermal Overload Relays and Accessories	31-32
LS Electric Tesol 3-Pole Magnetic Contactors, Thermal Overload Relays and Accessories	33-36
LS Electric Metasol 3-Pole DC Magnetic Contactors	37
LS Electric Metasol 4-Pole Magnetic Contactors	38-39
LS Electric Metasol Thermal Overload Relays and Accessories	40-41
LS Electric Manual Motor Starters and Accessories	42-43
ETEK Isolators and Load Break Switches	44
LS Electric Soft Starters	45-47
M-Driver 900E and 900M Series Variable Speed Drive (AC220V, AC380V)	48
M-Driver 900G Series Variable Speed Drive (AC220V, AC380V)	49
M-Driver M980 Series IP66 Variable Speed Drive (AC220V, AC380V)	50
M-Driver PV500 Series Solar Variable Speed Drive (AC380V)	51
Sinee EM760 Series Variable Speed Drive (AC380V, AC525V)	52-53
LS Electric IP5A Series Variable Speed Drive (AC525V)	54
VSD Accessories, EMC/RFI filters, Input/Output Chokes, Brake Resistors	55
VSD Accessories, Brake Units, PID Panels, Pressure Transducers, Potentiometers	56
Motors, IE3, IE1 and IE2 Flameproof	57
Gearboxes	58
LS Electric HMI and Block Type PLC	59
Temperature Controllers and Sensors, Power Supply and Cable Ties	60
ETEK Relays and Bases, Solid State Relays	61-62
ETEK Timers, Din Rail Mount and Base Mount	63
Push Buttons, Selector Switches, E-Stops, Key Switches and Accessories	64-66
Pilot Lights, Buzzers, Tower Lights and Pendant controls	67-68
ETEK Mild Steel Enclosures.	69
Merlin M250 Enclosures and VSD Enclosures	70
Fans and Fan Filter Kits	71
Foot Switches	72
Micro Switches and Limit Switches	73-75
Proximity Sensors	76

## Terms and Conditions – Price List

### Visual Representation:

All images in this price list are for marketing and visual representation only. Actual products may vary in appearance, specifications, or configuration.

### Information Accuracy:

Information provided in this price list is compiled to the best of our knowledge at the time of release. While every effort is made to ensure accuracy, Iron Side Electrical & Automation (Pty) Ltd do not accept responsibility for any errors, omissions, or inaccuracies contained herein.

### Pricing:

All prices listed are in **South African Rand (ZAR)** and are for **reference purposes only**. Prices are subject to change **without prior notice** and may vary depending on market conditions, availability, or exchange rate fluctuations. Prices **exclude VAT (15%)**, transportation, labor, and any third-party service costs unless explicitly stated.

### Minimum Orders & Availability:

Minimum order quantities may apply. All products are offered **subject to stock availability** at the time of order.

### Ownership and Use:

This catalogue remains the property of **Iron Side Electrical and Automation (Pty) Ltd**. It may not be **copied, altered, distributed, or shared** in any form without **prior written consent** from the Director or authorized representative of Iron Side Electrical and Automation (Pty) Ltd.

### Right to Correct Errors:

Iron Side Electrical and Automation (Pty) Ltd reserves the right to correct any errors or omissions in good faith without obligation or liability.

### Legal Jurisdiction:

## EKM3 Miniature Circuit Breakers 1Amp - 63Amp

### EKM3 SINGLE POLE – 4.5kA C-Curve MCB

Code	Icu AC415V	Curve	Pole	Amp	List Price
EKM3-63S-C-106	4.5kA	C-Curve	1 Pole	6 Amp	R76,00
EKM3-63S-C-110	4.5kA	C-Curve	1 Pole	10 Amp	R76,00
EKM3-63S-C-116	4.5kA	C-Curve	1 Pole	16 Amp	R76,00
EKM3-63S-C-120	4.5kA	C-Curve	1 Pole	20 Amp	R76,00
EKM3-63S-C-125	4.5kA	C-Curve	1 Pole	25 Amp	R76,00
EKM3-63S-C-132	4.5kA	C-Curve	1 Pole	32 Amp	R76,00
EKM3-63S-C-140	4.5kA	C-Curve	1 Pole	40 Amp	R76,00
EKM3-63S-C-150	4.5kA	C-Curve	1 Pole	50 Amp	R88,00
EKM3-63S-C-163	4.5kA	C-Curve	1 Pole	63 Amp	R88,00



### EKM3 DOUBLE POLE – 4.5kA C-Curve MCB

Code	Icu AC415V	Curve	Pole	Amp	List Price
EKM3-63S-C-206	4.5kA	C-Curve	2 Pole	6 Amp	R149,00
EKM3-63S-C-210	4.5kA	C-Curve	2 Pole	10 Amp	R149,00
EKM3-63S-C-216	4.5kA	C-Curve	2 Pole	16 Amp	R149,00
EKM3-63S-C-220	4.5kA	C-Curve	2 Pole	20 Amp	R149,00
EKM3-63S-C-225	4.5kA	C-Curve	2 Pole	25 Amp	R149,00
EKM3-63S-C-232	4.5kA	C-Curve	2 Pole	32 Amp	R149,00
EKM3-63S-C-240	4.5kA	C-Curve	2 Pole	40 Amp	R149,00
EKM3-63S-C-250	4.5kA	C-Curve	2 Pole	50 Amp	R176,00
EKM3-63S-C-263	4.5kA	C-Curve	2 Pole	63 Amp	R176,00



### EKM3 TRIPLE POLE – 4.5kA C-Curve MCB

Code	Icu AC415V	Curve	Pole	Amp	List Price
EKM3-63S-C-306	4.5kA	C-Curve	3 Pole	6 Amp	R235,00
EKM3-63S-C-310	4.5kA	C-Curve	3 Pole	10 Amp	R235,00
EKM3-63S-C-316	4.5kA	C-Curve	3 Pole	16 Amp	R235,00
EKM3-63S-C-320	4.5kA	C-Curve	3 Pole	20 Amp	R235,00
EKM3-63S-C-325	4.5kA	C-Curve	3 Pole	25 Amp	R235,00
EKM3-63S-C-332	4.5kA	C-Curve	3 Pole	32 Amp	R235,00
EKM3-63S-C-340	4.5kA	C-Curve	3 Pole	40 Amp	R235,00
EKM3-63S-C-350	4.5kA	C-Curve	3 Pole	50 Amp	R264,00
EKM3-63S-C-363	4.5kA	C-Curve	3 Pole	63 Amp	R264,00

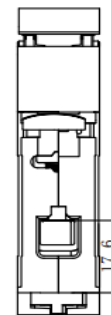
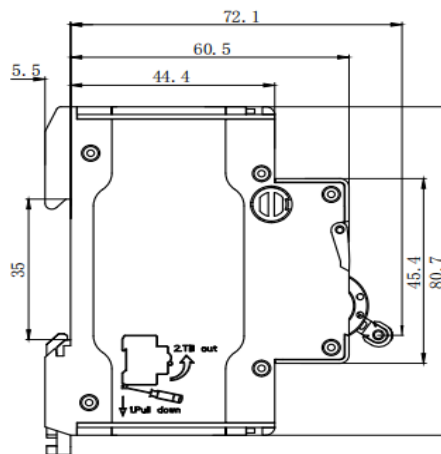
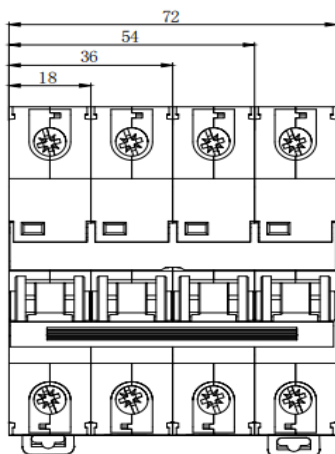

## EKM3 Miniature Circuit Breakers 1Amp - 63Amp

### EKM3 SINGLE POLE – 6kA C-Curve MCB

Code	Icu AC415V	Curve	Pole	Amp	List Price
EKM3-63-C-101	6kA	C-Curve	1 Pole	1 Amp	R121,00
EKM3-63-C-102	6kA	C-Curve	1 Pole	2 Amp	R121,00
EKM3-63-C-104	6kA	C-Curve	1 Pole	4 Amp	R121,00
EKM3-63-C-106	6kA	C-Curve	1 Pole	6 Amp	R121,00
EKM3-63-C-110	6kA	C-Curve	1 Pole	10 Amp	R121,00
EKM3-63-C-116	6kA	C-Curve	1 Pole	16 Amp	R121,00
EKM3-63-C-120	6kA	C-Curve	1 Pole	20 Amp	R121,00
EKM3-63-C-125	6kA	C-Curve	1 Pole	25 Amp	R121,00
EKM3-63-C-132	6kA	C-Curve	1 Pole	32 Amp	R121,00
EKM3-63-C-140	6kA	C-Curve	1 Pole	40 Amp	R121,00
EKM3-63-C-150	6kA	C-Curve	1 Pole	50 Amp	R129,00
EKM3-63-C-163	6kA	C-Curve	1 Pole	63 Amp	R129,00



### EKM3 DOUBLE POLE – 6kA C-Curve MCB

Code	Icu AC415V	Curve	Pole	Amp	List Price
EKM3-63-C-206	6kA	C-Curve	2 Pole	6 Amp	R231,00
EKM3-63-C-210	6kA	C-Curve	2 Pole	10 Amp	R231,00
EKM3-63-C-216	6kA	C-Curve	2 Pole	16 Amp	R231,00
EKM3-63-C-220	6kA	C-Curve	2 Pole	20 Amp	R231,00
EKM3-63-C-225	6kA	C-Curve	2 Pole	25 Amp	R231,00
EKM3-63-C-232	6kA	C-Curve	2 Pole	32 Amp	R231,00
EKM3-63-C-240	6kA	C-Curve	2 Pole	40 Amp	R231,00
EKM3-63-C-250	6kA	C-Curve	2 Pole	50 Amp	R258,00
EKM3-63-C-263	6kA	C-Curve	2 Pole	63 Amp	R258,00



### EKM3 TRIPLE POLE – 6kA C-Curve MCB

Code	Icu AC415V	Curve	Pole	Amp	List Price
EKM3-63-C-306	6kA	C-Curve	3 Pole	6 Amp	R344,00
EKM3-63-C-310	6kA	C-Curve	3 Pole	10 Amp	R344,00
EKM3-63-C-316	6kA	C-Curve	3 Pole	16 Amp	R344,00
EKM3-63-C-320	6kA	C-Curve	3 Pole	20 Amp	R344,00
EKM3-63-C-325	6kA	C-Curve	3 Pole	25 Amp	R344,00
EKM3-63-C-332	6kA	C-Curve	3 Pole	32 Amp	R344,00
EKM3-63-C-340	6kA	C-Curve	3 Pole	40 Amp	R344,00
EKM3-63-C-350	6kA	C-Curve	3 Pole	50 Amp	R387,00
EKM3-63-C-363	6kA	C-Curve	3 Pole	63 Amp	R387,00

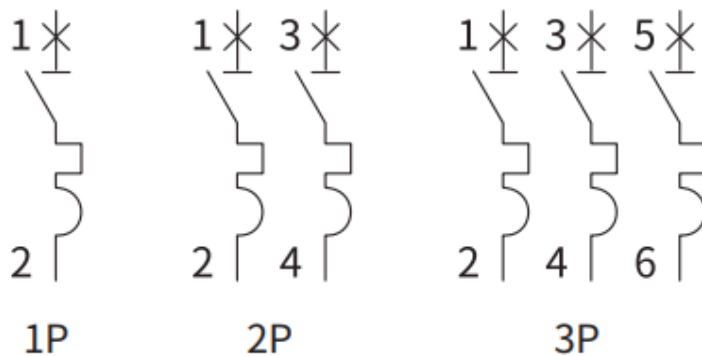

## EKM3 SINGLE POLE – 6kA D-Curve MCB

Code	Icu AC415V	Curve	Pole	Amp	List Price
EKM3-63-D-106	6kA	D-Curve	1 Pole	6 Amp	R128,00
EKM3-63-D-110	6kA	D-Curve	1 Pole	10 Amp	R128,00
EKM3-63-D-116	6kA	D-Curve	1 Pole	16 Amp	R128,00
EKM3-63-D-120	6kA	D-Curve	1 Pole	20 Amp	R128,00
EKM3-63-D-125	6kA	D-Curve	1 Pole	25 Amp	R128,00
EKM3-63-D-132	6kA	D-Curve	1 Pole	32 Amp	R128,00
EKM3-63-D-140	6kA	D-Curve	1 Pole	40 Amp	R128,00
EKM3-63-D-150	6kA	D-Curve	1 Pole	50 Amp	R138,00
EKM3-63-D-163	6kA	D-Curve	1 Pole	63 Amp	R138,00



## EKM3 DOUBLE POLE – 6kA D-Curve MCB

Code	Icu AC415V	Curve	Pole	Amp	List Price
EKM3-63-D-206	6kA	D-Curve	2 Pole	6 Amp	R250,00
EKM3-63-D-210	6kA	D-Curve	2 Pole	10 Amp	R250,00
EKM3-63-D-216	6kA	D-Curve	2 Pole	16 Amp	R250,00
EKM3-63-D-220	6kA	D-Curve	2 Pole	20 Amp	R250,00
EKM3-63-D-225	6kA	D-Curve	2 Pole	25 Amp	R250,00
EKM3-63-D-232	6kA	D-Curve	2 Pole	32 Amp	R250,00
EKM3-63-D-240	6kA	D-Curve	2 Pole	40 Amp	R250,00
EKM3-63-D-250	6kA	D-Curve	2 Pole	50 Amp	R270,00
EKM3-63-D-263	6kA	D-Curve	2 Pole	63 Amp	R270,00



## EKM3 TRIPLE POLE – 6kA D-Curve MCB

Code	Icu AC415V	Curve	Pole	Amp	List Price
EKM3-63-D-306	6kA	D-Curve	3 Pole	6 Amp	R375,00
EKM3-63-D-310	6kA	D-Curve	3 Pole	10 Amp	R375,00
EKM3-63-D-316	6kA	D-Curve	3 Pole	16 Amp	R375,00
EKM3-63-D-320	6kA	D-Curve	3 Pole	20 Amp	R375,00
EKM3-63-D-325	6kA	D-Curve	3 Pole	25 Amp	R375,00
EKM3-63-D-332	6kA	D-Curve	3 Pole	32 Amp	R375,00
EKM3-63-D-340	6kA	D-Curve	3 Pole	40 Amp	R375,00
EKM3-63-D-350	6kA	D-Curve	3 Pole	50 Amp	R425,00
EKM3-63-D-363	6kA	D-Curve	3 Pole	63 Amp	R425,00



### Tripping Characteristic (IEC60947-2)

Current(A)	Rated current(A)	Thermal Release				Magnetic release		
		Non-tripping current(A)	Tripping current(A)	Non-tripping time(h)	Tripping time(h)	Holding time(S)	Tripping time(S)	
10In±20%	8-12In	1-63	1.05In	1.30In	≤1	<1	≤0.2	<0.2
			1.05In	1.30In	≤2	<2	≤0.2	<0.2
	80-125	1.05In	1.30In	≤1	<1	≤0.2	<0.2	
		1.05In	1.30In	≤2	<2	≤0.2	<0.2	

## EKM3 Miniature Circuit Breakers 63Amp - 125Amp

### EKM3 TRIPLE POLE – 10kA C-Curve MCB

Code	Icu AC415V	Curve	Pole	Amp	List Price
EKM3-125H-C-3063	10kA	C-Curve	3 Pole	63 Amp	R924,00
EKM3-125H-C-3080	10kA	C-Curve	3 Pole	80 Amp	R924,00
EKM3-125H-C-3100	10kA	C-Curve	3 Pole	100 Amp	R924,00
EKM3-125H-C-3125	10kA	C-Curve	3 Pole	125 Amp	R924,00



### EKM3 TRIPLE POLE – 10kA D-Curve MCB

Code	Icu AC415V	Curve	Pole	Amp	List Price
EKM3-125H-D-363	10kA	D-Curve	3 Pole	63 Amp	R974,00
EKM3-125H-D-380	10kA	D-Curve	3 Pole	80 Amp	R974,00
EKM3-125H-D-3100	10kA	D-Curve	3 Pole	100 Amp	R974,00
EKM3-125H-D-3125	10kA	D-Curve	3 Pole	125 Amp	R974,00



### ACCESSORIES FOR EKM3 MCB

Code	For	Description	List Price
EKM3-OF	MCB	AUXILIARY 1NO + 1NC	R142,00
131506	MCB	63Amp 1P Busbar 1Meter	R225,00
131511	MCB	63Amp 3P Busbar 1Meter	R558,00
131513	MCB	100Amp 3P Busbar 1Meter	R756,00
ADR1200/FSB	MCB/DB	ALUM DIN RAIL 1MTR	R80,00

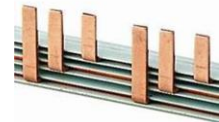

### EKL6 RCCB WITHOUT OVERLOAD

#### EKL6 1-POLE + N RCCB

Code	Icu Conditional	Curve	Pole	Amp	List Price
EKL6-100H-1-40A	6kA	30mA	1P+N	40A	R663,00
EKL6-100H-1-63A	6kA	30mA	1P+N	63A	R561,00

#### EKL6 3-POLE + N RCCB

Code	Icu Conditional	Curve	Pole	Amp	List Price
EKL6-100H-3-63A	6kA	30mA	3P+N	63A	R1 080,00
EKL6-100H-3-100A	6kA	100mA	3P+N	100A	R1 270,00



### EKU SURGE PROTECTION DEVICE

#### SPD SURGE PROTECTION - AC DIN MOUNT

Code	Description	List Price
EKU5T2401PN275	SPD Type T2 40kA 1P+NPE 275V	R774,00
EKU5T2403PN385	SPD Type T2 40kA 3P+NPE 385V	R1 610,00
EKU5T1+T2-385	SPD Type T1+T2 60kA 3P + NPE 385V	R4 378,00



#### SPD SURGE PROTECTION - DC DIN MOUNT

Code	Description	List Price
EKU5T240PV2M600	SPD Type PV 40kA 2P 600VDC	R631,00
EKU5T240PV2M800	SPD Type PV 40kA 2P 800VDC	R710,00
EKU5T240PV21000	SPD Type PV 40kA 2P 1000VDC	R847,00



## EKM8 THERMAL MAGNETIC FIXED TYPE MCCB



- Standard: IEC60947-2
- Poles: 3P,4P
- Frame size: 125, 160, 250, 400, 630, 800, 1250, 2000AF
- Rated voltage: AC415V
- Rated insulation voltage: AC1000V
- Ambient Temperature: -25...+40 °C

### EKM8 3-POLE 32AMP - 1600AMP

Code	Type	Pole	Amp	Icu 415V	List Price
EKM8-125H-3-0032	FIXED TYPE	3 Pole	32 Amp	25kA	R1 610,00
EKM8-125H-3-0040	FIXED TYPE	3 Pole	40 Amp	25kA	R1 610,00
EKM8-125H-3-0050	FIXED TYPE	3 Pole	50 Amp	25kA	R1 610,00
EKM8-125H-3-0063	FIXED TYPE	3 Pole	63 Amp	25kA	R1 610,00
EKM8-125H-3-0080	FIXED TYPE	3 Pole	80 Amp	25kA	R1 610,00
EKM8-125H-3-0100	FIXED TYPE	3 Pole	100 Amp	25kA	R1 610,00
EKM8-125H-3-0125	FIXED TYPE	3 Pole	125 Amp	25kA	R1 610,00
EKM8-160H-3-0140	FIXED TYPE	3 Pole	140 Amp	35kA	R1 990,00
EKM8-160H-3-0160	FIXED TYPE	3 Pole	160 Amp	35kA	R1 990,00
EKM8-250H-3-0125	FIXED TYPE	3 Pole	125 Amp	35kA	R2 386,00
EKM8-250H-3-0140	FIXED TYPE	3 Pole	140 Amp	35kA	R2 386,00
EKM8-250H-3-0150	FIXED TYPE	3 Pole	150 Amp	35kA	R2 386,00
EKM8-250H-3-0160	FIXED TYPE	3 Pole	160 Amp	35kA	R2 386,00
EKM8-250H-3-0180	FIXED TYPE	3 Pole	180 Amp	35kA	R2 386,00
EKM8-250H-3-0200	FIXED TYPE	3 Pole	200 Amp	35kA	R2 386,00
EKM8-250H-3-0225	FIXED TYPE	3 Pole	225 Amp	35kA	R2 386,00
EKM8-250H-3-0250	FIXED TYPE	3 Pole	250 Amp	35kA	R2 386,00
EKM8-400H-3-0315	FIXED TYPE	3 Pole	315 Amp	50kA	R7 160,00
EKM8-400H-3-0350	FIXED TYPE	3 Pole	350 Amp	50kA	R7 160,00
EKM8-400H-3-0400	FIXED TYPE	3 Pole	400 Amp	50kA	R7 160,00
EKM8-630H-3-0450	FIXED TYPE	3 Pole	450 Amp	50kA	R9 960,00
EKM8-630H-3-0500	FIXED TYPE	3 Pole	500 Amp	50kA	R9 960,00
EKM8-630H-3-0630	FIXED TYPE	3 Pole	630 Amp	50kA	R9 960,00
EKM8-800H-3-0800	FIXED TYPE	3 Pole	800 Amp	65kA	R12 900,00
EKM8-1250H-3-1000	FIXED TYPE	3 Pole	1000 Amp	65 kA	R23 750,00
EKM8-1250H-3-1250	FIXED TYPE	3 Pole	1250 Amp	65 kA	R28 410,00
EKM8-1600H-3-1600	FIXED TYPE	3 Pole	1600 Amp	65kA	R36 470,00



### EKM8 4-POLE 160AMP - 1600AMP

Code	Type	Pole	Amp	Icu 415V	List Price
EKM8-250H-4-0160	MCCB Breaker	4 Pole	160 Amp	35kA	R2 960,00
EKM8-250H-4-0200	MCCB Breaker	4 Pole	200 Amp	35kA	R2 960,00
EKM8-250H-4-0250	MCCB Breaker	4 Pole	250 Amp	35kA	R2 960,00
EKM8-400H-4-0315	MCCB Breaker	4 Pole	315 Amp	50kA	R8 950,00
EKM8-400H-4-0400	MCCB Breaker	4 Pole	400 Amp	50kA	R8 950,00
EKM8-630H-4-0500	MCCB Breaker	4 Pole	500 Amp	50kA	R12 760,00
EKM8-630H-4-0630	MCCB Breaker	4 Pole	630 Amp	50kA	R12 760,00
EKM8-800H-4-0800	MCCB Breaker	4 Pole	800 Amp	50kA	R16 040,00
EKM8-1250H-4-1000	MCCB Breaker	4 Pole	1000 Amp	50kA	R28 400,00
EKM8-1250H-4-1250	MCCB Breaker	4 Pole	1250 Amp	50kA	R35 260,00
EKM8-1600H-4-1600	MCCB Breaker	4 Pole	1600 Amp	50kA	R46 900,00



## EKM8T THERMAL & MAGNETIC ADJUSTABLE MCCB



- Standard: IEC60947-2
- Frame size: 125,160,250,400,630,800,1250AF
- Rated operational voltage: 230/400/415/690V
- Breaking capacity code: C, S, H
- Number of poles: 3P, 4P
- Trip unit type: thermal magnetic type
- Installation method: Fixed type or plug-in type
- Thermal adjustable range (0.8~1)In, magnetic adjustable range(5~10)In

### EKM8T 3-POLE 160AMP - 1250AMP 0.8-1.0

Code	Type	Pole	Amp	Icu 415V	List Price
EKM8T-160H-3-0160	ADJUSTABLE	3 Pole	160A	25kA	R3 682,00
EKM8T-250H-3-0200	ADJUSTABLE	3 Pole	200A	35kA	R5 166,00
EKM8T-250H-3-0250	ADJUSTABLE	3 Pole	250A	35kA	R5 166,00
EKM8T-400H-3-0315	ADJUSTABLE	3 Pole	315A	50kA	R10 178,00
EKM8T-400H-3-0400	ADJUSTABLE	3 Pole	400A	50kA	R10 178,00
EKM8T-630H-3-0500	ADJUSTABLE	3 Pole	500A	50kA	R11 354,00
EKM8T-630H-3-0630	ADJUSTABLE	3 Pole	630A	50kA	R11 354,00
EKM8T-800H-3-0800	ADJUSTABLE	3 Pole	800A	60kA	R16 710,00
EKM8T-1250H-3-1250	ADJUSTABLE	3 Pole	1250A	100kA	R36 933,00



### EKM8T 4-POLE 160AMP - 1250AMP 0.8-1.0

Code	Type	Pole	Amp	Icu 415V	List Price
EKM8T-160H-4-0160	ADJUSTABLE	4 Pole	160A	25kA	R4 713,00
EKM8T-250H-4-0200	ADJUSTABLE	4 Pole	200A	35kA	R6 830,00
EKM8T-250H-4-0250	ADJUSTABLE	4 Pole	250A	35kA	R6 830,00
EKM8T-400H-4-0315	ADJUSTABLE	4 Pole	315A	50kA	R12 874,00
EKM8T-400H-4-0400	ADJUSTABLE	4 Pole	400A	50kA	R12 874,00
EKM8T-630H-4-0500	ADJUSTABLE	4 Pole	500A	50kA	R15 138,00
EKM8T-630H-4-0630	ADJUSTABLE	4 Pole	630A	50kA	R15 138,00
EKM8T-800H-4-0800	ADJUSTABLE	4 Pole	800A	60kA	R22 280,00
EKM8T-1250H-4-1250	ADJUSTABLE	4 Pole	1250A	100kA	R47 866,00



 **Pro Tip:**

When using thermal adjustable MCCBs on motors, always leave space for ventilation inside the panel. Excess heat affects the trip curve and long-term reliability.

## EKM8E ELECTRONIC ADJUSTABLE MCCB



- Standard: IEC60947-2
- Poles: 3P,4P
- Frame size: 160,250,400,630,800,1250,1600,2000AF
- Rated operational voltage: 230/400/415/690V
- Rated insulation voltage: 1000V
- Trip unit type: electronic type
- Breaking capacity code: S,H
- Installation method: Fixed type; plug-in type
- Adjustable Tripping Setting: IR, Isd, li or Ir, tR, tsd, Ip
- Ambient Temperature: -25...+40 °C

### EKM8E 3-POLE 250AMP - 1600AMP 0.4-1.0

Code	Type	Pole	Amp	Icu 415V	List Price
EKM8E-250H-3-0250	ELECTRONIC	3 Pole	250A	35kA	R7 264,00
EKM8E-400H-3-0400	ELECTRONIC	3 Pole	400A	50kA	R14 562,00
EKM8E-630H-3-0630	ELECTRONIC	3 Pole	630A	50kA	R18 454,00
EKM8E-800H-3-0800	ELECTRONIC	3 Pole	800A	60kA	R28 130,00
EKM8E-1250H-3-1250	ELECTRONIC	3 Pole	1250A	60kA	R38 270,00
EKM8E-1600H-3-1600	ELECTRONIC	3 Pole	1600A	100kA	R54 390,00



### EKM8E 4-POLE 250AMP - 1600AMP 0.4-1.0

Code	Type	Pole	Amp	Icu 415V	List Price
EKM8E-250H-4-0250	ELECTRONIC	4 Pole	250A	35kA	R9 443,00
EKM8E-400H-4-0400	ELECTRONIC	4 Pole	400A	50kA	R18 930,00
EKM8E-630H-4-0630	ELECTRONIC	4 Pole	630A	50kA	R23 990,00
EKM8E-800H-4-0800	ELECTRONIC	4 Pole	800A	60kA	R36 569,00
EKM8E-1250H-4-1250	ELECTRONIC	4 Pole	1250A	60kA	R47 151,00
EKM8E-1600H-4-1600	ELECTRONIC	4 Pole	1600A	100kA	R64 860,00



## EKM8 MCCB ACCESSORIES

### EKM8 EXTENDED HANDLES

Code	For	Frame	List Price
EKM8M0125	EKM8	125 FRAME	R1 100,00
EKM8M0160	EKM8	160 FRAME	R1 250,00
EKM8M0250	EKM8	250 FRAME	R1 250,00
EKM8M0630	EKM8	630 FRAME	R1 730,00
EKM8M1250	EKM8	1250 FRAME	R2 450,00



#### Quick Fit Reminder

Before final tightening, **test the full ON/OFF rotation** of the handle with the door open. This helps catch any binding or incorrect shaft depth before commissioning.

## AUX & ALARM CONTACTS

Code	For	Frame	List Price
EKM8-AA1250	EKM8	125-160	R218,00
EKM8-AA250	EKM8	250	R218,00
EKM8-AA400	EKM8	400-1250	R439,00



AX-250

## SHUNT TRIP

Code	Voltage	Frame	List Price
EKM8-SHT160-230	230VAC	160 FRAME	R481,00
EKM8-SHT250-230	230VAC	250 FRAME	R481,00
EKM8-SHT1250-230	230VAC	1250 FRAME	R1 201,00
EKM8-SHT160-415	415VAC	160 FRAME	R481,00
EKM8-SHT250-415	415VAC	250 FRAME	R481,00
EKM8-SHT1250-415	415VAC	1250 FRAME	R1 201,00



SHT-400

## UNDER VOLTAGE TRIP

Code	Voltage	Frame	List Price
EKM8-UVT160-230	230VAC	160 FRAME	R1 108,00
EKM8-UVT250-230	230VAC	250 FRAME	R1 108,00
EKM8-UVT1250-230	230VAC	1250 FRAME	R2 537,00
EKM8-UVT160-415	415VAC	160 FRAME	R1 108,00
EKM8-UVT250-415	415VAC	250 FRAME	R1 108,00
EKM8-UVT1250-415	415VAC	1250 FRAME	R2 537,00



UVR-250

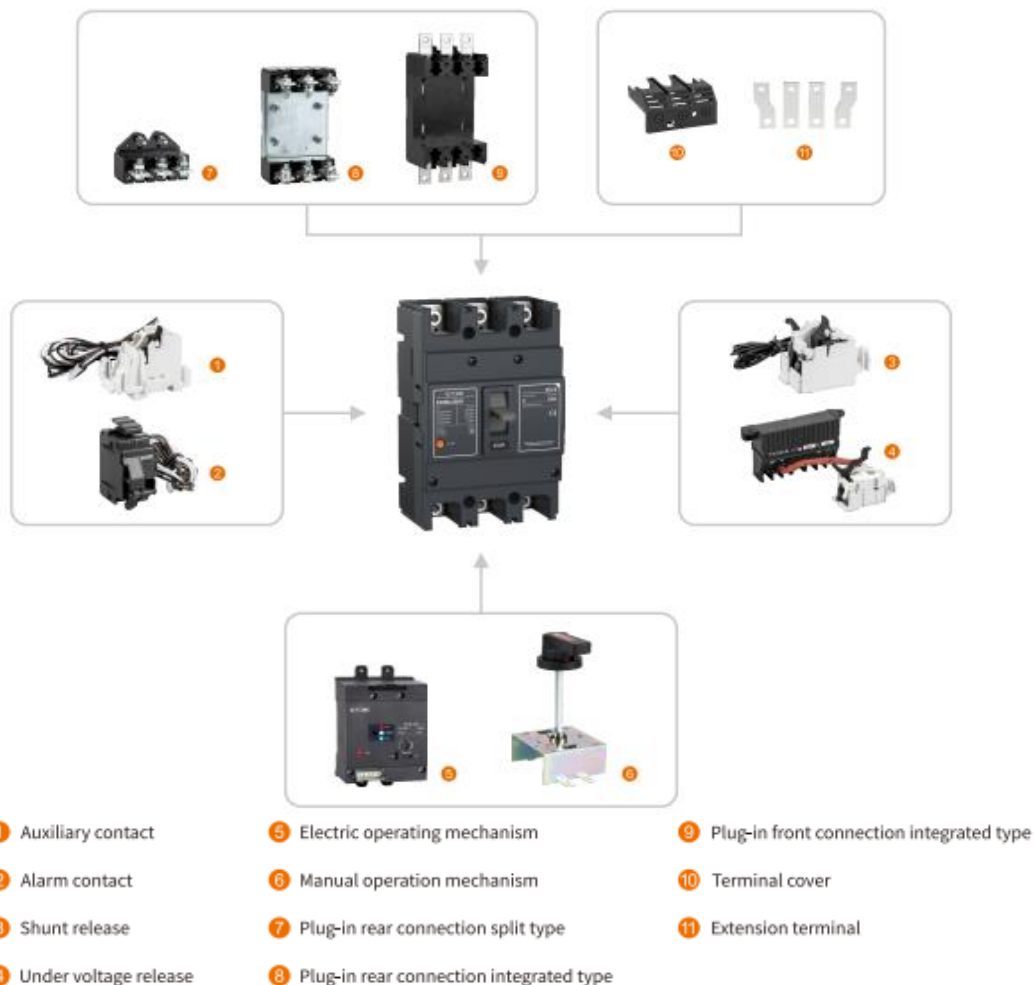

# CHANGE OVER SWITCHES



- Standard: IEC60947-3
- Compact design
- Rated Current: 63-125A
- Front operation with three stable positions I-O-II
- Off at middle position
- Can be mounted with other products viz MCB, RCCB, Isolator in distribution board
- Easy snap on DIN rail mounting

## EKCS DIN RAIL MOUNT C/O SWITCH

Code	Type	Amp	Pole	List Price
EKCS101H-2-63	Modular Changeover Switch	63A	2 Pole	R874,00
EKCS101H-4-63	Modular Changeover Switch	63A	4 Pole	R1 411,00

## EKCG BASE MOUNT ROTARY TYPE C/O SWITCH

Code	Type	Amp	Pole	List Price
EKCG1Z-160/4	Manual Transfer Switch	160A	4 Pole	R1 312,00
EKCG1Z-250/4	Manual Transfer Switch	250A	4 Pole	R1 931,00
EKCG1Z-400/4	Manual Transfer Switch	400A	4 Pole	R3 988,00
EKCG1Z-630/4	Manual Transfer Switch	630A	4 Pole	R4 914,00
EKCG1Z-1000/4	Manual Transfer Switch	1000A	4 Pole	R14 800,00
EKCG1Z-1250/4	Manual Transfer Switch	1250A	4 Pole	R16 710,00



## EKAT AUTOMATIC C/O SWITCH, 230VAC ATS

Code	Type	Amp	Pole	List Price
EKATS1-100/4	Automatic Transfer Switch	100A	4 Pole	R1 342,00
EKATS1-160/4	Automatic Transfer Switch	160A	4 Pole	R2 174,00
EKATS1-250/4	Automatic Transfer Switch	250A	4 Pole	R2 742,00
EKATS1-400/4	Automatic Transfer Switch	400A	4 Pole	R5 744,00
EKATS1-630/4	Automatic Transfer Switch	630A	4 Pole	R6 727,00
EKATS1-800/4	Automatic Transfer Switch	800A	4 Pole	R16 767,00
EKATS1-1000/4	Automatic Transfer Switch	1000A	4 Pole	R17 422,00
EKATS1-1250/4	Automatic Transfer Switch	1250A	4 Pole	R18 992,00
EKATS1-1600/4	Automatic Transfer Switch	1600A	4 Pole	R22 149,00
EKATS1-2000/4	Automatic Transfer Switch	2000A	4 Pole	R53 320,00

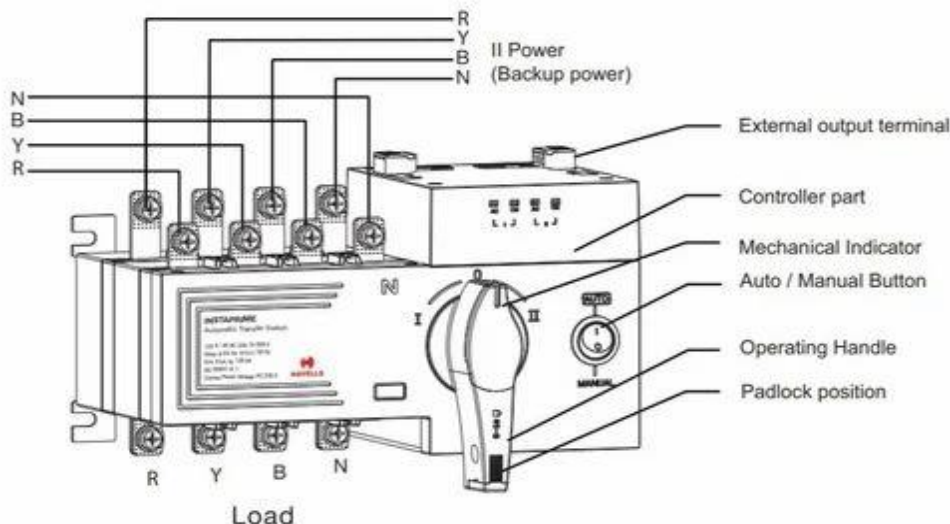

## EKMF MODULAR CONTACTORS



- Standard: IEC61095, IEC60947-4-1
- Rated current: 16~100A
- Rated operational voltage: 250V,1P(1NO,1NC), 2P(2NO,2NC,1NO+1NC) 400V, 3P(3NO,3NC),4P(4NO,4NC,2NO+2NC,3NO+1NC)
- Rated Insulation voltage (Ui): 500V
- Coil Voltage: 24V/110V/230V
- Utilization Category: AC-7a (AC-1), AC-7b(AC-3)
- Method of Control: Automatic
- Mounting: 35mm Din rail

### EKMF 2-POLE, DIN RAIL | DB MOUNT

Code	Amp	Coil Volt	Contact	List Price
EKMF-2520-230	25A	AC230V	2NO	R275,00
EKMF-2511-230	25A	AC230V	1NO+1N	R275,00
EKMF-4020-230	40A	AC230V	2NO	R561,00
EKMF-6320-230	63A	AC230V	2NO	R828,00
EKMF-8020-230	80A	AC230V	2NO	R1 147,00
EKMF-8040-230	80A	AC230V	4NO	R1 643,00



### EKMF 4-POLE, DIN RAIL | DB MOUNT

Code	Amp	Coil Volt	Contact	List Price
EKMF-2540-230	25A	230VAC	4NO	R469,00
EKMF-4040-230	40A	230VAC	4NO	R829,00
EKMF-6340-230	63A	230VAC	4NO	R1 175,00
EKMF-6322-230	63A	230VAC	2NO+2NC	R829,00



## EKMF MODULAR CONTACTORS WITH HANDLE

### EKMF 2-POLE, DIN RAIL | DB MOUNT

Code	Amp	Coil Volt	Contact	List Price
EKMF-2520M-230	25A	230VAC	2NO	R388,00
EKMF-4020M-230	40A	230VAC	2NO	R825,00
EKMF-6320M-230	63A	230VAC	2NO	R1 175,00



### EKMF 4-POLE, DIN RAIL | DB MOUNT

Code	Amp	Coil Volt	Contact	List Price
EKMF-2540M-230	25A	230VAC	4NO	R639,00
EKMF-4040M-230	40A	230VAC	4NO	R1 175,00
EKMF-6340M-230	63A	230VAC	4NO	R1 426,00
EKMF-6322M-230	63A	230VAC	2NO+2NC	R1 180,00



### EKMF ACCESSORIES

Code	Description	List Price
EKMF-OF-11	Auxiliary Contactor for EKM 1NO+1NC	R187,00
EKMF-SPC	Spacers for EKMF	R16,00



#### 🔊 Pro Tip: Use Where Silence Matters

Unlike traditional contactors, the EKMF is engineered for **silent operation** — making it ideal for **bedrooms, hospitals, schools, and conference rooms** where noise must be minimized.

## FUSES, FUSE HOLDERS AND BASES

### EKFL AC FUSE HOLDER WITH LED,

Code	Amp	Pole	List Price
EKF1-32L-1	32A	1-POLE	R55,00
EKF1-32L-2	32A	2-POLE	R115,00



### EKFL AC FUSE LINK 10X38

Code	Amp	Current	List Price
EKFL-1001	1A	AC	R12,00
EKFL-1002	2A	AC	R12,00
EKFL-1004	4A	AC	R12,00
EKFL-1006	6A	AC	R12,00
EKFL-1010	10A	AC	R12,00
EKFL-1016	16A	AC	R12,00
EKFL-1020	20A	AC	R12,00
EKFL-1025	25A	AC	R12,00



### EKF1 DC FUSE HOLDER (PV) 10X38

Code	Amp	Current	List Price
EKF1-10XPV-2010	1000V	DC	R115,00



### EKFL DC FUSE LINK (PV) 10X38

Code	Amp	Current	List Price
EKFL1001016	1000V	DC	R49,00
EKFL1001020	1000V	DC	R49,00
EKFL1001025	1000V	DC	R49,00

### NH FUSE BASE 1POLE

Code	Pole	List Price
NH0-B160	1 Pole	R196,00
NH1-B250	1 Pole	R248,00



### NH FUSE HOLDER 3POLE

Code	Pole	List Price
HYCR17-100A	3 Pole	R980,00
HYCR17-160A	3 Pole	R1 060,00
HYCR17-250A	3 Pole	R1 620,00
HYCR17-400A	3 Pole	R1 940,00
HYCR17-630A	3 Pole	R2 370,00



### NH FUSE LINK

Code	Voltage	Current	List Price
NH00-100A	AC500V	AC	R115,00
NH00-125A	AC500V	AC	R115,00
NH00-160A	AC500V	AC	R115,00
NH1-200A	AC500V	AC	R230,00
NH1-250A	AC500V	AC	R230,00
NH1-315A	AC500V	AC	R340,00
NH2-355A	AC500V	AC	R340,00
NH2-400A	AC500V	AC	R340,00



**Did you know?** Fuses were first designed in the mid-19th century, around 1864, by Thomas Edison during his work on electrical distribution systems. He patented a fuse-like safety device in 1890 to protect telegraph and lighting circuits from overcurrent.

## EKC2 MAGNETIC CONTACTORS



### EKC2M MINIATURE CONTACTOR 3-POLE DC COIL

Code	AC3 380/415V	AC1	Coil	AC3 380/415V	Contacts	List Price
EKC2-1210MZ-24	12A	20A	DC24V	5.5kW	1NO	R595,00
EKC2-1210MZ-240			DC220V			

### EKC2M MINIATURE CONTACTOR 3-POLE AC COIL

Code	AC3 380/415V	AC1	Coil	AC3 380/415V	Contacts	List Price
EKC2-0910M-24			AC24V			
EKC2-0910M-48			AC48V			
EKC2-0910M-110	9A	20A	AC110V	4.0kW	1NO	R296,00
EKC2-0910M-240			AC240V			
EKC2-0910M-415			AC415V			
EKC2-1210M-24			AC24V			
EKC2-1210M-48			AC48V			
EKC2-1210M-110	12A	20A	AC110V	5.5kW	1NO	R324,00
EKC2-1210M-240			AC240V			
EKC2-1210M-415			AC415V			

### EKC2M REVERSING CONTACTOR 3-POLE REVERSING

Code	AC3 380/415V	AC1	Coil	AC3 380/415V	Contacts	List Price
EKC2-1210MN-24			AC24V			
EKC2-1210MN-48			AC48V			
EKC2-1210MN-110	12A	20A	AC110V	5.5kW	Dual	R1 190,00
EKC2-1210MN-240			AC240V			
EKC2-1210MN-415			AC415V			

**Did you know?**  
Miniature magnetic contactors typically consume **less than 4W** of coil power, helping reduce heat buildup in dense control enclosures.

### ACCESSORIES FOR EKC2 MINI CONTACTOR

Code	Description	Contacts	Price
EKF4-22M	AUXILLIARY CONTACT TOP MOUNT	2NO+2NC	R93,00



#### Dimension(mm)

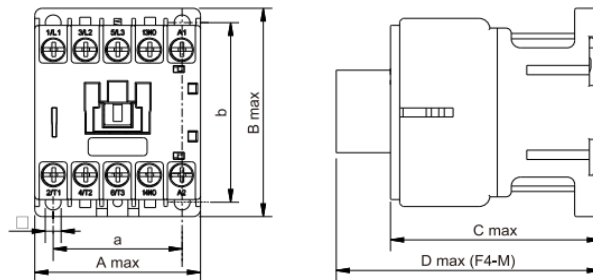

Model	A Max	B Max	C Max	D Max	a	b	Ø
EKC2-06M~12M	45.5	59	58	94	35±0.35	50±0.48	4.2
EKC2-06M/Z~12M/Z	45.5	59	70	106	35±0.35	50±0.48	4.2

## EKC1 DC MAGNETIC CONTACTORS



### EKC1 CONTACTOR 3-POLE WITH DC COIL

Code	AC3 380/415V	AC4 380/415V	Coil	AC3 380/415V	Contacts	List Price
EKC1-1210Z-BD	12A	5A	DC24V	5.5KW	1NO	R770,00
EKC1-1210Z-ED			DC48V			
EKC1-1810Z-BD	18A	7.7A	DC24V	7.5KW	1NO	R860,00
EKC1-1810Z-ED			DC48V			
EKC1-2510Z-BD	25A	8.5A	DC24V	11KW	1NO	R1 170,00
EKC1-2510Z-ED			DC48V			
EKC1-3210Z-BD	32A	12A	DC24V	15KW	1NO	R1 360,00
EKC1-3210Z-ED			DC48V			

### EKC1 CONTACTOR 4-POLE MULTI-CONFIGURATION

Code	AC3 380/415V	AC4 380/415V	Coil	AC3 380/415V	Contacts	List Price
EKC1-1804-24			AC24V			
EKC1-1804-48	18A	7.7A	AC48V	7.5KW	4NO	R414,00
EKC1-1804-110			AC110V			
EKC1-1804-220			AC220V			
EKC1-1808-24			AC24V			
EKC1-1808-48	18A	7.7A	AC48V	7.5KW	2NO+2NC	R415,00
EKC1-1808-110			AC110V			
EKC1-1808-220			AC220V			
EKC1-3204-24			AC24V			
EKC1-3204-48	32A	12A	AC48V	15KW	4NO	R987,00
EKC1-3204-110			AC110V			
EKC1-3204-220			AC220V			
EKC1-3208-24			AC24V			
EKC1-3208-48	32A	12A	AC48V	15KW	2NO+2NC	R987,00
EKC1-3208-110			AC110V			
EKC1-3208-220			AC220V			

### EKC1 CONTACTOR ACCESSORIES

Code	Description	Contacts	Price
EKF4-11	FRONT MOUNT AUX	1NO+1NC	R62,00
EKF4-22	FRONT MOUNT AUX	2NO+2NC	R93,00
EKF8-11	SIDE MOUNT AUX	1NO+1NC	R110,00
EKF5-T2	PNEUMATIC TIMER		R579,00
EKA9-0932	REVERSER/INTERLOCK KIT EKC1 9AMP-32AMF		R46,00



## EKC1 DC MAGNETIC CONTACTORS



### EKC2 CONTACTOR 3-POLE AC

Code	AC3 380/415V	AC4 380/415V	Coil	AC3 380/415V	Contacts	List Price
EKC2-0911-24			AC24V			
EKC2-0911-48			AC48V			
EKC2-0911-110	9A	3.5A	AC110V	4.0KW	1NO+1NC	R328,00
EKC2-0911-240			AC240V			
EKC2-0911-415			AC415V			
EKC2-1211-24			AC24V			
EKC2-1211-48			AC48V			
EKC2-1211-110	12A	5A	AC110V	5.5KW	1NO+1NC	R350,00
EKC2-1211-240			AC240V			
EKC2-1211-415			AC415V			
EKC2-1811-24			AC24V			
EKC2-1811-48			AC48V			
EKC2-1811-110	18A	7.7A	AC110V	7.5KW	1NO+1NC	R388,00
EKC2-1811-240			AC240V			
EKC2-1811-415			AC415V			
EKC2-2511-24			AC24V			
EKC2-2511-48			AC48V			
EKC2-2511-110	25A	8.5A	AC110V	11KW	1NO+1NC	R518,00
EKC2-2511-240			AC240V			
EKC2-2511-415			AC415V			
EKC2-3211-24			AC24V			
EKC2-3211-48			AC48V			
EKC2-3211-110	32A	12A	AC110V	15KW	1NO+1NC	R664,00
EKC2-3211-240			AC240V			
EKC2-3211-415			AC415V			
EKC2-3811-24			AC24V			
EKC2-3812-48			AC48V			
EKC2-3813-110	38A	17A	AC110V	15KW	1NO+1NC	R780,00
EKC2-3814-240			AC240V			
EKC2-3815-415			AC415V			
EKC2-4011-24			AC24V			
EKC2-4011-48			AC48V			
EKC2-4011-110	40A	18.5A	AC110V	18.5KW	1NO+1NC	R1 221,00
EKC2-4011-240			AC240V			
EKC2-4011-415			AC415V			

 **Did you know?**

The first magnetic contactor was designed by Westinghouse in 1902.

# EKC2 MAGNETIC CONTACTORS



## EKC2 CONTACTOR 3-POLE AC

Code	AC3 380/415V	AC4 380/415V	Coil	AC3 380/415V	Contacts	List Price
EKC2-5011-24			AC24V			
EKC2-5011-48			AC48V			
EKC2-5011-110	50A	24A	AC110V	22KW	1NO+1NC	R1 270,00
EKC2-5011-240			AC240V			
EKC2-5011-415			AC415V			
EKC2-6511-24			AC24V			
EKC2-6511-48			AC48V			
EKC2-6511-110	65A	28A	AC110V	30KW	1NO+1NC	R1 515,00
EKC2-6511-240			AC240V			
EKC2-6511-415			AC415V			
EKC2-8011-24			AC24V			
EKC2-8011-48			AC48V			
EKC2-8011-110	80A	37A	AC110V	37KW	1NO+1NC	R2 280,00
EKC2-8011-240			AC240V			
EKC2-8011-415			AC415V			
EKC2-9511-24			AC24V			
EKC2-9511-48			AC48V			
EKC2-9511-110	95A	44A	AC110V	45KW	1NO+1NC	R2 470,00
EKC2-9511-240			AC240V			
EKC2-9511-415			AC415V			
EKC2-115-24			AC24V			
EKC2-115-110	115A	52A	AC110V	55KW	1NO+1NC	R4 500,00
EKC2-115-240			AC240V			
EKC2-115-415			AC415V			
EKC2-150-24			AC24V			
EKC2-150-110	150A	60A	AC110V	75KW	1NO+1NC	R4 840,00
EKC2-150-240			AC240V			
EKC2-150-415			AC415V			
EKC2-185-24			AC24V			
EKC2-185-110	185A	79	AC110V	93KW	1NO+1NC	R6 050,00
EKC2-185-240			AC240V			
EKC2-185-415			AC415V			
EKC2-225-24			AC24V			
EKC2-225-110	225A	85A	AC110V	110KW	1NO+1NC	R7 300,00
EKC2-225-240			AC240V			
EKC2-225-415			AC415V			

### 💡 Did you know?

The **AC-3** rating on the ETEK EKC2 contactor refers to starting and stopping squirrel cage motors under **normal running conditions** — like pumps and fans.

The **AC-4** rating is for more demanding applications, such as **inching, plugging, or rapid reversing**, where the contactor opens under heavy arcing conditions.

Always choose the correct duty class to ensure contactor longevity and safe operation!

## EKC2 MAGNETIC CONTACTORS



### EKC2 CONTACTOR 3-POLE AC

Code	AC3 380/415V	AC4 380/415V	Coil	AC3 380/415V	Contacts	List Price
EKC2-265-110			AC110V			
EKC2-265-240	265A	105A	AC240V	132KW	1NO+1NC	R9 860,00
EKC2-265-415			AC415V			
EKC2-330-110			AC110V			
EKC2-330-240	330A	117A	AC240V	160KW	1NO+1NC	R10 800,00
EKC2-330-415			AC415V			
EKC2-400-110			AC110V			
EKC2-400-240	400A	138A	AC240V	200KW	1NO+1NC	R12 400,00
EKC2-400-415			AC415V			
EKC2-500-110			AC110V			
EKC2-500-240	500A	147A	AC240V	250KW	1NO+1NC	R19 200,00
EKC2-500-415			AC415V			
EKC2-630-110			AC110V			
EKC2-630-240	630A	188	AC240V	315KW	1NO+1NC	R28 900,00
EKC2-630-415			AC415V			
EKC2-800-110			AC110V			
EKC2-800-240	800A	195A	AC240V	400KW	1NO+1NC	R33 200,00
EKC2-800-415			AC415V			

## EKC2SU CONTACTORS, BUILT-IN SURGE SUPPRESSION

### EKC2SU CONTACTOR 3-POLE AC240V

Code	AC3 380/415V	AC1 380/415V	Coil	AC3 380/415V	Contacts	List Price
EKC2SU-1211	12A	25A	AC240V	5.5kW	1NO+1NC	R486,00
EKC2SU-1811	18A	30A	AC240V	7.5kW	1NO+1NC	R539,00
EKC2SU-2511	25A	40A	AC240V	11kW	1NO+1NC	R717,00
EKC2SU-3211	32A	50A	AC240V	15kW	1NO+1NC	R922,00
EKC2SU-4011	40A	60A	AC240V	18.5kW	1NO+1NC	R1 555,00
EKC2SU-5011	50A	80A	AC240V	22kW	1NO+1NC	R1 760,00
EKC2SU-6511	65A	80A	AC240V	30kW	1NO+1NC	R2 149,00
EKC2SU-8011	80A	100A	AC240V	37kW	1NO+1NC	R3 181,00
EKC2SU-9511	95A	125A	AC240V	45kW	1NO+1NC	R3 345,00



## EKC2W CONTACTORS, WIDE RANGE VOLTAGE 110-250VDC

Code	AC3 380/415V	AC1 380/415V	AC3 380/415V	Contacts	List Price
<b>EKC2SU CONTACTOR 3-POLE AC/DC110-240V</b>					
Code	AC3 380/415V	AC1 380/415V	AC3 380/415V	Contacts	List Price
EKC2W-1811	18A	30A	7.5kW	1NO+1NC	R1 460,00
EKC2W-3211	32A	50A	15kW	1NO+1NC	R2 376,00
EKC2W-4011	40A	60A	18.5kW	1NO+1NC	R3 862,00
EKC2W-5011	50A	80A	22kW	1NO+1NC	R4 020,00
EKC2W-6511	65A	80A	30kW	1NO+1NC	R4 810,00



## EKC2 MAGNETIC CONTACTORS ACCESSORIES



### EKC2 CONTACTOR AUXILIARIES

Code	Description	Contacts	List Price
EKF4-11	FRONT-MOUNT AUX	1NO+1NC	R62,00
EKF4-04	FRONT-MOUNT AUX	4NC	R93,00
EKF4-40	FRONT-MOUNT AUX	4NO	R93,00
EKF4-22	FRONT-MOUNT AUX	2NO+2NC	R93,00
EKF8-11	SIDE MOUNT AUX	1NO+1NC	R110,00

### EKC2 CONTACTOR TIMER

Code	Description	Config	List Price
EKF5-T2	PNEUMATIC TIMER, 0.1-30SEC	DELAY-ON	R579,00

### EKC2 CONTACTOR MECHANICAL INTERLOCK

Code	Description	List Price
EKA9-0932	INTERLOCK FOR: EKC2- 09-32	R46,00
EKA9-4095	INTERLOCK FOR: EKC2-40-95	R77,00
EKA9-FF970	INTERLOCK FOR: EKC2F-115-150	R78,00
EKA9-FB970	INTERLOCK FOR: EKC2F-185-225	R78,00
EKA9-FH970	INTERLOCK FOR: EKC2F-265-330	R143,00
EKA9-FJ970	INTERLOCK FOR: EKC2F-400-500	R143,00
EKA9-FL970	INTERLOCK FOR: EKC2F-630-800	R161,00

## EKC2 CONTACTORS, SPARE COILS

### EKC2 SPARE COIL 24V, 48V, 110V, 240V, 415V

Code	Description	List Price
EKC2-COIL-09/18	Coil for EKC2-09/18	R135,00
EKC2-COIL-25/38	Coil for EKC2-25/38	R185,00
EKC2-COIL-40/65	Coil for EKC2-40/65	R320,00
EKC2-COIL-80/95	Coil for EKC2-80/95	R380,00
EKC1/2-COIL-115/150	Coil for EKC1 and EKC2-115/150	R1 075,00
EKC1/2-COIL-185/225	Coil for EKC1 and EKC2-185/225	R1 370,00
EKC1/2-COIL-265/330	Coil for EKC1 and EKC2-265/330	R1 610,00
EKC1/2-COIL-400	Coil for EKC1 and EKC2-400	R2 085,00
EKC1/2-COIL-500	Coil for EKC1 and EKC2-500	R2 160,00
EKC1/2-COIL-630	Coil for EKC1 and EKC2-630	R2 350,00
EKC1/2-COIL-800	Coil for EKC1 and EKC2-800	R2 710,00



## EKR2 THERMAL OVERLOAD RELAY FOR EKC2 CONTACTORS

### THERMAL O/L RELAY WITH PHASE FAILURE

Code	Range	AC3 AC380V	List Price
EKR2-0.63A	0.4-0.63 Amp	0.12/0.18kW	R318,00
EKR2-1A	0.63-1 Amp	0.25kW	R318,00
EKR2-1.6A	1-1.6 Amp	0.37/0.55kW	R318,00
EKR2-2.5A	1.6-2.5 Amp	0.75kW	R318,00
EKR2-4A	2.5-4 Amp	1.1/1.5kW	R318,00
EKR2-6A	4-6 Amp	2.2kW	R318,00
EKR2-8A	5.5-8 Amp	3kW	R318,00
EKR2-10A	7-10 Amp	4kW	R318,00
EKR2-13A	9-13 Amp	5.5kW	R318,00
EKR2-18A	12-18 Amp	7.5kW	R318,00
EKR2-25A	17-25 Amp	11kW	R318,00
EKR2-32A	23-32 Amp	15kW	R450,00
EKR2-40A	30-40 Amp	18.5kW	R711,00
EKR2-50A	37-50 Amp	22kW	R711,00
EKR2-65A	48-65 Amp	30kW	R711,00
EKR2-70A	55-70 Amp	30/37kW	R711,00
EKR2-80A	63-80 Amp	37kW	R711,00
EKR2-93A	80-93 Amp	45kW	R711,00



Larger thermal overload relays available on request.

#### 👉 Using Bimetal Thermal Overload Relays

Ensure the overload relay is sized according to the motor's full load current (FLC).

Always verify tight and clean terminal connections to prevent heat buildup.

Mount the relay vertically to maintain accurate thermal response.

Avoid placing relays near external heat sources that may cause false tripping.

Allow proper ventilation around the relay for consistent performance.

Test the manual and automatic reset functions during commissioning.

Regularly inspect for signs of wear or corrosion on the bimetal elements.

## EKMS2 MOTOR PROTECTION CIRCUIT BREAKERS



- Rated Voltage: Up to 690V AC
- Rated Current: Up to 80A
- Motor Types: Suitable for single-phase and three-phase AC motors
- Protection Features: Overload, short circuit, phase failure, and temperature compensation
- Compliance: Meets relevant IEC/EN standards for motor protection devices

### EKMS2-32 PUSH BUTTON TYPE

Part Number	Range (A)	ICU/KA	AC415V	Price
EKMS2-0.63A	0.4-0.63Amp	100KA	0.12kW	R735,00
EKMS2-1A	0.63-1 Amp	100KA	0.25kW	R735,00
EKMS2-1.6A	1-1.6 Amp	100KA	0.37/0.55kW	R735,00
EKMS2-2.5A	1.6-2.5 Amp	100KA	0.75kW	R735,00
EKMS2-4A	2.5-4 Amp	100KA	1.1/1.5kW	R735,00
EKMS2-6.3A	4-6.3 Amp	100KA	2.2kW	R735,00
EKMS2-10A	6-10 Amp	100KA	4.0kW	R735,00
EKMS2-14A	9-14 Amp	15KA	5.5kW	R735,00
EKMS2-18A	13-18 Amp	15KA	7.5kW	R735,00
EKMS2-23A	17-23 Amp	15KA	11.0kW	R735,00
EKMS2-25A	20-25 Amp	15KA	11.0kW	R735,00
EKMS2-32A	24-32 Amp	15KA	15.0kW	R913,00
EKMS2-40A	25-40 Amp	15KA	18.5kW	R1 882,00
EKMS2-63A	40-63 Amp	15KA	30.0kW	R1 882,00
EKMS2-80A	56-80 Amp	15KA	37.5kW	R1 882,00



### EKMS2R ROTARY TYPE

Part Number	Fits to	ICU/KA	AC415V	Price
EKMS2R-10A	6-10 Amp	100KA	4.0kW	R882,00
EKMS2R-14A	9-14 Amp	15KA	5.5kW	R882,00
EKMS2R-18A	13-18 Amp	15KA	7.5kW	R882,00
EKMSR-23A	17-23 Amp	15KA	11.0kW	R882,00
EKMS2R-25A	20-25 Amp	15KA	11.0kW	R882,00
EKMS2R-32A	24-32 Amp	15KA	15.0kW	R882,00



### EKMS2 AUXILIARIES

Part Number	Description	Price
EKMS2-AE20-32	Aux Top 2NO	R74,00
EKMS2-AE11-32	Aux Top 1NO/1NC	R74,00
EKMS2-AN20-32	Aux Side 2NO	R146,00
EKMS2-AN11-32	Aux Side 1NO/1NC	R146,00
EKMS2-AU11-80	Aux Side 1NO/1NC	R146,00

Instantaneous auxiliary contact



### EKMS2 AUXILIARIES

Part Number	Description	Price
EKMS2-MC	MMS ENCLOSURE IP55	R293,00



### EKMS2 BUSBAR COMB

Part Number	Description	Price
PB-322	2-WAY EKMS-2	POR
PB-323	3-WAY EKMS-2	POR
PB-325	5-WAY EKMS-2	R380,00



## EKQ1 DOL STARTER, ENCLOSED IEC60947-4-1

### DOL, METAL BASE, PVC TOP IP55

Code	Control Voltage	Range	Power	List Price
EKQ1-220-4	AC220V	2.5-4A	0.37KW	R1 490,00
EKQ1-220-6	AC220V	4-6A	0.55KW	R1 490,00
EKQ1-220-8	AC220V	5.5-8A	0.75KW	R1 490,00
EKQ1-400-4	AC380V	2.5-4A	1.5KW	R1 490,00
EKQ1-400-6	AC380V	4-6A	2.2KW	R1 490,00
EKQ1-400-8	AC380V	5.5-8A	3.0KW	R1 490,00



## EKQ2 DOL STARTER, ENCLOSED IEC60947-4-1

### DOL, PVC IP65

Code	Control Voltage	Range	Power	List Price
EKQ2-220-1.6A	AC220V	1-1.6A	0.18KW	R1 386,00
EKQ2-220-2.5A	AC220V	1.6-2.5A	0.25KW	R1 386,00
EKQ2-220-4A	AC220V	2.5-4A	0.37KW	R1 386,00
EKQ2-220-6A	AC220V	4-6A	0.55KW	R1 386,00
EKQ2-220-8A	AC220V	5.5-8A	0.75KW	R1 386,00
EKQ2-220-10A	AC220V	7-10A	1.1KW	R1 386,00
EKQ2-220-13A	AC220V	9-13A	1.5KW	R1 386,00
EKQ2-220-18A	AC220V	12-18A	2.2KW	R1 386,00
EKQ2-220-25A	AC220V	17-25A	3.0KW	R1 470,00
EKQ2-220-32A	AC220V	23-32A	4.0KW	R1 470,00
EKQ2-400-1.6A	AC380V	1-1.6A	0.55KW	R1 386,00
EKQ2-400-2.5A	AC380V	1.6-2.5A	0.75KW	R1 386,00
EKQ2-400-4A	AC380V	2.5-4A	1.5KW	R1 386,00
EKQ2-400-6A	AC380V	4-6A	2.2KW	R1 386,00
EKQ2-400-8A	AC380V	5.5-8A	3.0KW	R1 386,00
EKQ2-400-10A	AC380V	7-10A	4.0KW	R1 386,00
EKQ2-400-13A	AC380V	9-13A	5.5KW	R1 386,00
EKQ2-400-18A	AC380V	12-18A	7.5KW	R1 386,00
EKQ2-400-25A	AC380V	17-25A	11KW	R1 470,00
EKQ2-400-32A	AC380V	23-32A	15KW	R1 470,00

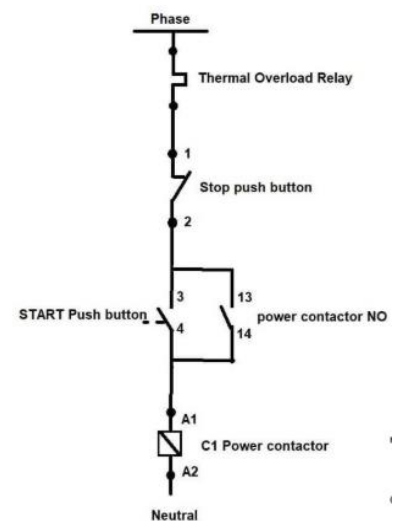

 Need a custom DOL or Star-Delta Starter? Contact us for a quote.

### Operation and Installation Condition

- Altitude: ≤2000m.
- Ambient air temperature: -5°C~+40°C, average temperature of 24 hours must be below +35°C.
- Relative humidity: the maximum temperature of 40 degrees, the air relative humidity not exceed 50%, at a lower temperature can allow for a higher relative humidity. The wettest month's average lowest temperature must be below 25°C, the max relative humidity of that month should not exceed 90%. If humidity changes as a result of occasional gel generated, should eliminate it.
- Installation position: The installation degree of the tilt and vertical plane should not exceed 5°.
- In a non-explosive hazardous medium, and there is no place in the medium that is sufficient to corrode metals and destroy insulation gases and conductor dust.
- Where there is rain and snow protection and there is no steam.
- Shock vibration: Products should be installed and used without severe shake, shock and vibration of the place.

## ABN | ABS THERMAL MAGNETIC MCCB, 14-37KA

### 3-POLE 15AMP - 1200AMP, FIXED TYPE

Code	Type	Pole	Amperage	Icu AC415V	List Price
ABN53C-15A	FIXED	3-POLE	15A	14kA	R1 250,00
ABN53C-20A	FIXED	3-POLE	20A	14kA	R1 250,00
ABN53C-30A	FIXED	3-POLE	30A	14kA	R1 250,00
ABN53C-40A	FIXED	3-POLE	40A	14kA	R1 250,00
ABN63C-60A	FIXED	3-POLE	60A	14KA	R1 419,00
ABN103C-30A	FIXED	3-POLE	30A	18KA	R1 545,00
ABN103C-40A	FIXED	3-POLE	40A	18KA	R1 545,00
ABN103C-50A	FIXED	3-POLE	50A	18KA	R1 545,00
ABN103C-60A	FIXED	3-POLE	60A	18KA	R1 545,00
ABN103C-75A	FIXED	3-POLE	75A	18KA	R1 545,00
ABN103C-100A	FIXED	3-POLE	100A	18KA	R1 545,00
ABN203C-100A	FIXED	3-POLE	100A	25KA	R3 022,00
ABN203C-125A	FIXED	3-POLE	125A	25KA	R3 022,00
ABN203C-150A	FIXED	3-POLE	150A	25KA	R3 022,00
ABN203C-175A	FIXED	3-POLE	175A	25KA	R3 022,00
ABN203C-200A	FIXED	3-POLE	200A	25KA	R3 022,00
ABN203C-225A	FIXED	3-POLE	225A	25KA	R3 022,00
ABN203C-250A	FIXED	3-POLE	250A	25KA	R3 120,00
ABN403C-250A	FIXED	3-POLE	250A	37KA	R7 811,00
ABN403C-300A	FIXED	3-POLE	300A	37KA	R7 811,00
ABN403C-350A	FIXED	3-POLE	350A	37KA	R7 811,00
ABN403C-400A	FIXED	3-POLE	400A	37KA	R7 811,00
ABN803C-500A	FIXED	3-POLE	500A	37KA	R14 355,00
ABN803C-630A	FIXED	3-POLE	630A	37KA	R14 355,00
ABN803C-700A	FIXED	3-POLE	700A	37KA	R16 170,00
ABN803C-800A	FIXED	3-POLE	800A	37KA	R16 170,00
ABS1003B-1000A	FIXED	3-POLE	1000A	37KA	R37 996,00
ABS1203B-1200A	FIXED	3-POLE	1200A	37KA	R41 160,00

### 4-POLE 15AMP - 1200AMP, FIXED TYPE

Code	Type	Pole	Amperage	Icu AC415V	List Price
ABN54C-15A	FIXED	4-POLE	15A	14kA	R1 588,00
ABN54C-20A	FIXED	4-POLE	20A	14kA	R1 588,00
ABN54C-30A	FIXED	4-POLE	30A	14kA	R1 588,00
ABN54C-40A	FIXED	4-POLE	40A	14kA	R1 588,00
ABN64C-60A	FIXED	4-POLE	60A	14KA	R1 671,00
ABN104C-30A	FIXED	4-POLE	30A	18KA	R1 883,00
ABN104C-40A	FIXED	4-POLE	40A	18KA	R1 883,00
ABN104C-50A	FIXED	4-POLE	50A	18KA	R1 883,00
ABN104C-60A	FIXED	4-POLE	60A	18KA	R1 883,00
ABN104C-75A	FIXED	4-POLE	75A	18KA	R1 883,00
ABN104C-100A	FIXED	4-POLE	100A	18KA	R1 883,00
ABN204C-100A	FIXED	4-POLE	100A	25KA	R3 506,00
ABN204C-125A	FIXED	4-POLE	125A	25KA	R3 506,00
ABN204C-150A	FIXED	4-POLE	150A	25KA	R3 506,00
ABN204C-175A	FIXED	4-POLE	175A	25KA	R3 506,00
ABN204C-200A	FIXED	4-POLE	200A	25KA	R3 506,00
ABN204C-225A	FIXED	4-POLE	225A	25KA	R3 506,00
ABN204C-250A	FIXED	4-POLE	250A	25KA	R3 885,00
ABN404C-250A	FIXED	4-POLE	250A	37KA	R8 867,00
ABN404C-300A	FIXED	4-POLE	300A	37KA	R8 867,00
ABN404C-350A	FIXED	4-POLE	350A	37KA	R8 867,00
ABN404C-400A	FIXED	4-POLE	400A	37KA	R8 867,00
ABN804C-500A	FIXED	4-POLE	500A	37KA	R15 958,00
ABN804C-630A	FIXED	4-POLE	630A	37KA	R15 958,00
ABN804C-700A	FIXED	4-POLE	700A	37KA	R20 475,00
ABN804C-800A	FIXED	4-POLE	800A	37KA	R20 475,00
ABS1004B-1000A	FIXED	4-POLE	1000A	37KA	R41 371,00
ABS1204B-1200A	FIXED	4-POLE	1200A	37KA	R47 744,00



## ABS THERMAL MAGNETIC MCCB, 37KA

### 3-POLE 100-250AMP, ADJUSTABLE 0,7-1,0

Code	Type	Pole	Amperage	Icu AC415V	List Price
ABS203C-FMU-100A	ADJUST	3-POLE	100A	37KA	R4 310,00
ABS203C-FMU-125A	ADJUST	3-POLE	125A	37KA	R4 310,00
ABS203C-FMU-160A	ADJUST	3-POLE	160A	37KA	R4 310,00
ABS203C-FMU-200A	ADJUST	3-POLE	200A	37KA	R4 310,00
ABS203C-FMU-250A	ADJUST	3-POLE	250A	37KA	R4 310,00



## ABN | ABS MCCB ACCESSORIES

### ABN|ABS ROTARY HANDLES

Code	Type	For	List Price
DH100	DIRECT PADLOCKABLE	ABN53-103C	R803,00
DH250	DIRECT PADLOCKABLE	ABN/S 203C	R803,00
N-70S	DIRECT PADLOCKABLE	ABN403C	R1 689,00
N-80S	DIRECT PADLOCKABLE	ABN803C	R1 689,00
DHK100	DIRECT WITH KEY LOCK	ABN53-103C	R1 280,00
DHK250	DIRECT WITH KEY LOCK	ABN/S203C	R1 280,00
EH100	EXTENDED PADLOCKABLE	ABN53-103C	R1 205,00
EH250	EXTENDED PADLOCKABLE	ABN/S203C	R1 205,00
E-70U	EXTENDED PADLOCKABLE	ABN403C	R2 673,00
E-80U	EXTENDED PADLOCKABLE	ABN803C	R3 074,00

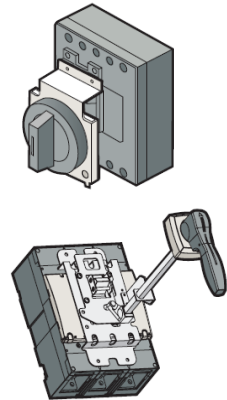

### ABN|ABS AUXILIARY AND ALARM

Code	Type	For	List Price
AX-LWT 1NO+1NC	LWT 1NO+1NC	ABN/S 53-203C	R383,00
AX-LWT 1NO+1NC	LWT 1NO+1NC	ABN403-803C	R428,00
AX-LWT 1NO+1NC	LWT 1NO+1NC	ABS1003-1203B	R493,00
AX-TBT 1NO+1NC	TBT 1NO+1NC	ABN/S 53-203C	R428,00
AX-TBT 1NO+1NC	TBT 1NO+1NC	ABN403-803C	R472,00
AL-LWT 1NO+1NC	LWT 1NO+1NC	ABN/S 53-203C	R383,00
AL-LWT 1NO+1NC	LWT 1NO+1NC	ABN403-803C	R428,00
AL-LWT 1NO+1NC	LWT 1NO+1NC	ABS1003-1203B	R493,00
AL-TBT 1NO+1NC	TBT 1NO+1NC	ABN/S 53-203C	R428,00
AL-TBT 1NO+1NC	TBT 1NO+1NC	ABN403-803C	R472,00
AX+AL-LWT 1NO+1NC	LWT 1NO+1NC	ABN/S 53-203C	R758,00
AX+AL-LWT 1NO+1NC	LWT 1NO+1NC	ABN403-803C	R848,00
AX+AL-LWT 1NO+1NC	LWT 1NO+1NC	ABS1003-1203B	R981,00
AX+AL-TBT 1NO+1NC	TBT 1NO+1NC	ABN/S 53-203C	R848,00
AX+AL-TBT 1NO+1NC	TBT 1NO+1NC	ABN403-803C	R937,00

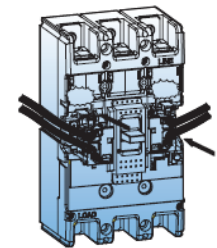

### ABN|ABS SHUNT TRIP

Code	Voltage	For	List Price
SHT TBT-ABN/S 53-203C	DC12V	ABN/S 53-203C	R653,00
SHT TBT-ABN/S 53-203C	AC/DC 24-30V	ABN/S 53-203C	R653,00
SHT TBT-ABN/S 53-203C	AC/DC 48-60V	ABN/S 53-203C	R653,00
SHT TBT-ABN/S 53-203C	AC/DC 100-130V	ABN/S 53-203C	R653,00
SHT TBT-ABN/S 53-203C	AC/DC 200-250V	ABN/S 53-203C	R653,00
SHT TBT-ABN/S 53-203C	AC 380-450V	ABN/S 53-203C	R653,00
SHT TBT-ABN/S 53-203C	AC 440-500V	ABN/S 53-203C	R653,00
SHT TBT-ABN 403-803C	DC12V	ABN 403-803C	R1 205,00
SHT TBT-ABN 403-803C	AC/DC 24-30V	ABN 403-803C	R1 205,00
SHT TBT-ABN 403-803C	AC/DC 48-60V	ABN 403-803C	R1 205,00
SHT TBT-ABN 403-803C	AC/DC 100-130V	ABN 403-803C	R1 205,00
SHT TBT-ABN 403-803C	AC/DC 200-250V	ABN 403-803C	R1 205,00
SHT TBT-ABN 403-803C	AC 380-450V	ABN 403-803C	R1 205,00
SHT TBT-ABN 403-803C	AC 440-500V	ABN 403-803C	R1 205,00

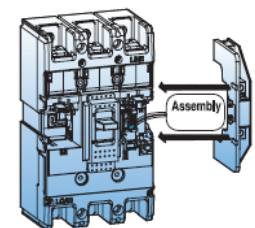

## ABN|ABS MCCB ACCESSORIES

### ABN|ABS UNDER VOLTAGE TRIP

Code	Voltage	For	List Price
LS-UVT-1	AC/DC 24V	ABN/S 53-203C	R892,00
LS-UVT-2	AC/DC 48V	ABN/S 53-203C	R892,00
LS-UVT-3	AC/DC 100-110V	ABN/S 53-203C	R892,00
LS-UVT-4	AC/DC 200-220V	ABN/S 53-203C	R892,00
LS-UVT-5	AC 380-450V	ABN/S 53-203C	R892,00
LS-UVT-6	AC 440-480V	ABN/S 53-203C	R892,00
LS-UVT-7	AC/DC 24V	ABN 403-803C	R1 560,00
LS-UVT-8	AV/DC 48V	ABN 403-803C	R1 560,00
LS-UVT-9	AC/DC 100-110V	ABN 403-803C	R1 560,00
LS-UVT-10	AC/DC 200-220V	ABN 403-803C	R1 560,00
LS-UVT-11	AC 380-450V	ABN 403-803C	R1 560,00
LS-UVT-12	AC 440-480V	ABN 403-803C	R1 560,00

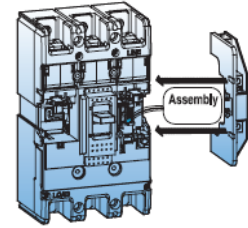

## TS THERMAL MAGNETIC MCCB 50-65KA

### 3-POLE 40AMP - 800AMP, ADJUSTABLE 0,8-1,0

Code	Type	Pole	Amperage	Icu AC415V	List Price
TS100N-FMU-	ADJUST	3-POLE	40A	50KA	R3 980,00
TS100N-FMU-	ADJUST	3-POLE	50A	50KA	R3 980,00
TS100N-FMU-	ADJUST	3-POLE	63A	50KA	R3 980,00
TS100N-FMU-	ADJUST	3-POLE	80A	50KA	R3 980,00
TS100N-FMU-	ADJUST	3-POLE	100A	50KA	R3 980,00
TS250N-FMU-	ADJUST	3-POLE	125A	50KA	R7 419,00
TS250N-FMU-	ADJUST	3-POLE	160A	50KA	R7 419,00
TS250N-FMU-	ADJUST	3-POLE	200A	50KA	R7 419,00
TS250N-FMU-	ADJUST	3-POLE	250A	50KA	R7 419,00
TS400N-FMU-	ADJUST	3-POLE	300A	65KA	R14 133,00
TS400N-FMU-	ADJUST	3-POLE	400A	65KA	R14 133,00
TS630N-FMU-	ADJUST	3-POLE	500A	65KA	R19 065,00
TS630N-FMU-	ADJUST	3-POLE	630A	65KA	R19 065,00
TS800N-FMU-	ADJUST	3-POLE	800A	65KA	R25 198,00



### 4-POLE 100AMP - 800AMP, ADJUSTABLE 0,8-1,0

Code	Type	Pole	Amperage	Icu AC415V	List Price
TS100N-FMU-100A	ADJUST	4-POLE	100A	50KA	R5 431,00
TS250N-FMU-125A	ADJUST	4-POLE	125A	50KA	R10 030,00
TS250N-FMU-160A	ADJUST	4-POLE	160A	50KA	R10 030,00
TS250N-FMU-200A	ADJUST	4-POLE	200A	50KA	R10 030,00
TS250N-FMU-250A	ADJUST	4-POLE	250A	50KA	R10 030,00
TS400N-FMU-300A	ADJUST	4-POLE	300A	65KA	R17 573,00
TS400N-FMU-400A	ADJUST	4-POLE	400A	65KA	R17 573,00
TS630N-FMU-500A	ADJUST	4-POLE	500A	65KA	R26 525,00
TS630N-FMU-630A	ADJUST	4-POLE	630A	65KA	R26 525,00
TS800N-FMU-800A	ADJUST	4-POLE	800A	65KA	R33 568,00



## TS ELECTRONIC ADJ MCCB 50-65KA

### 3-POLE 40AMP - 800AMP, ADJUSTABLE 0,4-1,0

Code	Type	Pole	Amperage	Icu AC415V	List Price
TS160N-ETS-160A	ELECTRONIC	3-POLE	160A	50KA	R6 840,00
TS250N-ETS-250A	ELECTRONIC	3-POLE	250A	50KA	R9 491,00
TS400N-ETS-400A	ELECTRONIC	3-POLE	400A	65KA	R17 365,00
TS630N-ETS-630A	ELECTRONIC	3-POLE	630A	65KA	R26 525,00
TS800N-ETS-800A	ELECTRONIC	3-POLE	800A	65KA	R30 253,00
TS1000N-NG5-1000A	ELECTRONIC	3-POLE	1000A	50KA	R57 386,00
TS1250N-NG5-1250A	ELECTRONIC	3-POLE	1250A	50KA	R63 193,00
TS1600N-NG5-1600A	ELECTRONIC	3-POLE	1600A	50KA	R75 255,00



## TS MCCB ACCESSORIES

### TS MCCB ROTARY HANDLES

Code	Type	For	List Price
DHK2-S	DIRECT, WITH KEY-LOCK	TS100-250	R1 862,00
DHK3-S	DIRECT, WITH KEY-LOCK	TS400-630	R2 694,00
DHK4-S	DIRECT, WITH KEY-LOCK	TS800	R3 087,00
DHK5-S	DIRECT, WITH KEY-LOCK	TS1600	R9 692,00
EH2-S	EXTENDED, PADLOCKABLE	TS100-250	R1 531,00
EH3-S	EXTENDED, PADLOCKABLE	TS400-630	R2 668,00
EH4-S	EXTENDED, PADLOCKABLE	TS800	R2 931,00
EH5-S	EXTENDED, PADLOCKABLE	TS1600	R8 372,00

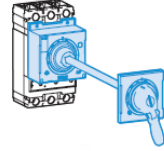
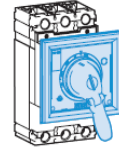

### TS MCCB AUXILIARIES AND ALARM

Code	Type	For	List Price
AX-TD100 - TS800	AUXILIARY 1NO+1NC	TD100 - TS800	R513,00
AX-TS1000 - TS1600	AUXILIARY 1NO+1NC	TS1000 - TS1600	R563,00
AL-TD100 - TS800	ALARM SWITCH	TD100 - TS800	R513,00
AL-TS1000 - TS1600	ALARM SWITCH	TS1000 - TS1600	R562,00



### TS MCCB SHUNT TRIP

Code	VOLTAGE	For	List Price
TS-SHT1	DC12V	TD100-TS800	R964,00
TS-SHT2	AC/DC 24V	TD100-TS800	R964,00
TS-SHT3	AC/DC 48V	TD100-TS800	R964,00
TS-SHT4	AC/DC 110-130V	TD100-TS800	R964,00
TS-SHT5	AC220-240V/DC250V	TD100-TS800	R964,00
TS-SHT6	AC 380-500V	TD100-TS800	R964,00
TS-SHT7	DC12V	TS1600	R1 828,00
TS-SHT8	AC/DC 24V	TS1600	R1 828,00
TS-SHT9	AC/DC 48V	TS1600	R1 828,00
TS-SHT10	AC/DC 110-130V	TS1600	R1 828,00
TS-SHT11	AC220-240V/DC250V	TS1600	R1 828,00
TS-SHT12	AC 380-500V	TS1600	R1 828,00



### TS MCCB UNDER VOLTAGE TRIP

Code	VOLTAGE	For	List Price
TS-UVT1	DC12V	TD100-TS800	R1 701,00
TS-UVT2	AC/DC 24V	TD100-TS800	R1 701,00
TS-UVT3	AC/DC 48V	TD100-TS800	R1 701,00
TS-UVT4	AC/DC 110-130V	TD100-TS800	R1 701,00
TS-UVT5	AC220-240V/DC250V	TD100-TS800	R1 701,00
TS-UVT6	AC 380-500V	TD100-TS800	R1 701,00
TS-UVT7	DC12V	TS1600	R2 318,00
TS-UVT8	AC/DC 24V	TS1600	R2 318,00
TS-UVT9	AC/DC 48V	TS1600	R2 318,00
TS-UVT10	AC/DC 110-130V	TS1600	R2 318,00
TS-UVT11	AC220-240V/DC250V	TS1600	R2 318,00
TS-UVT12	AC 380-500V	TS1600	R2 318,00



### TS MCCB MOTOR UNIT

Code	VOLTAGE	For	List Price
MOP-2-DC24V	DC24V	TS100-TS250	R8 686,00
MOP-2-110-220	AC100-240V/DC100-220V	TS100-TS250	R8 686,00
MOP-3-DC24V	DC24V	TS400-TS630	R11 804,00
MOP-3-110-220	AC100-240V/DC100-220V	TS400-TS630	R11 804,00
MOP-4-DC24V	DC24V	TS800	R14 032,00
MOP-4-110-220	AC100-240V/DC100-220V	TS800	R14 032,00

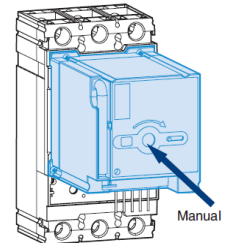

### TS MCCB ADD ON EARTH LEAKAGE UNIT

Code	Ratings	For	List Price
RTU23	0.3-10AMP, 460-690VAC	TS100 - TS250	R6 484,00
RTU33	0.3-10AMP, 460-690VAC	TS400 - TS630	R9 133,00
RTU43	0.3-10AMP, 460-690VAC	TS800	R12 250,00



## AIR CIRCUIT BREAKERS FIXED TYPE - METASOL

- Compact and robust design for reliable high-capacity protection
- Available in 3-pole and 4-pole configurations
- Advanced NG trip units (NG0 / NG5) for precise protection and monitoring
- Fixed mounting with easy front access for maintenance
- Wide range of accessories: motor operator, aux contacts, UVT/closing/trip coils
- High breaking capacity with fast interruption response
- Suitable for low-voltage distribution and main incomer applications
- Customizable control voltage and auxiliary options available on request



### 3-POLE FIXED TYPE ACB

Part Number	Rating (A)	Pole	Icu		List Price Excl VAT
			415V	690V	
AN-06D3-06H	630A	3P	65KA	50KA	R 45 949,00
AN-08D3-08H	800A	3P	65KA	50KA	R 51 164,00
AN-10D3-10H	1000A	3P	65KA	50KA	R 51 832,00
AN-13D3-13H	1250A	3P	65KA	50KA	R 56 411,00
AN-16D3-16H	1600A	3P	65KA	50KA	R 62 802,00
AS-20E3-20H	2000A	3P	65KA	50KA	R 88 049,00
AS-25E3-25H	2500A	3P	85KA	85KA	R 124 362,00
AS-32E3-32H	3200A	3P	85KA	85KA	R 142 932,00
AS-40E3-40V	4000A	3P	85KA	85KA	R 243 159,00
AS-50F3-50V	5000A	3P	100KA	100KA	R 257 627,00
AS-63G3-63V	6300A	3P	150KA	150KA	R 421 862,00

### 4-POLE FIXED TYPE ACB

Part Number	Rating (A)	Pole	Icu		List Price Excl VAT
			415V	690V	
AN-06D4-06H	630A	4P	65KA	50KA	R 53 008,00
AN-08D4-08H	800A	4P	65KA	50KA	R 58 192,00
AN-10D4-10H	1000A	4P	65KA	50KA	R 58 828,00
AN-13D4-13H	1250A	4P	65KA	50KA	R 64 996,00
AN-16D4-16H	1600A	4P	65KA	50KA	R 72 627,00
AS-20E4-20H	2000A	4P	65KA	50KA	R 105 889,00
AS-25E4-25H	2500A	4P		85KA	R 146 526,00
AS-32E4-32H	3200A	4P		85KA	R 173 204,00
AS-40E4-40V	4000A	4P		85KA	R 292 668,00
AS-50F4-50V	5000A	4P		100KA	R 310 220,00
AS-63G4-63H	6300A	4P		150KA	R 547 718,00

#### Please Note:

ACBs are supplied complete with NG0 or NG5 trip units, closing coil, trip coil, motor operator, 3NO/3NC auxiliary contacts, and mounting brackets. Please specify the required control voltage when placing your order.

## AIR CIRCUIT BREAKERS DRAW-OUT TYPE - METASOL

- Heavy-duty draw-out construction for easy maintenance and quick replacement
- Available in 3-pole and 4-pole configurations
- Equipped with NG0 or NG5 trip units for advanced protection and monitoring
- Integrated racking mechanism with safety interlocks
- Optional motor operator, UVT, closing/trip coils, and auxiliary contacts
- High breaking capacity with fast fault interruption
- Ideal for critical applications requiring safe disconnection and servicing
- Control voltage and accessory configurations customizable upon request



### 3-POLE DRAW-OUT TYPE ACB

Part Number	Rating (A)	Pole	Icu		List Price Excl VAT
			415V	690V	
AN-06D3-06A	630A	3P	65KA	50KA	R63 642,00
AN-08D3-08A	800A	3P	65KA	50KA	R65 748,00
AN-10D3-10A	1000A	3P	65KA	50KA	R67 179,00
AN-13D3-13A	1250A	3P	65KA	50KA	R77 454,00
AN-16D3-16A	1600A	3P	65KA	50KA	R83 516,00
AS-20D3-20A	2000A	3P	65KA	50KA	R113 374,00
AS-25E3-25A	2500A	3P		85KA	R143 268,00
AS-32E3-32A	3200A	3P		85KA	R172 910,00
AS-40E3-40A	4000A	3P		85KA	R258 568,00
AS-50F3-50A	5000A	3P		100KA	R273 878,00
AS-63G3-63A	6300A	3P		150KA	R445 864,00

 **Please note:** For 4-pole options or upgraded trip units, please contact us!  

## AIR CIRCUIT BREAKERS ACCESSORIES

### SHUNT TRIP AND CLOSING COIL

Part Number	Type	Voltage		List Price Excl VAT
		DC	AC	
SHT1-24	SHUNT TRIP	24-30V	-	R1 541,00
SHT1-48	SHUNT TRIP	48-60V	48V	R1 541,00
SHT1-110	SHUNT TRIP	100-130V	100-130V	R1 541,00
SHT1-240	SHUNT TRIP	200-250V	200-250V	R1 541,00
SHT1-415	SHUNT TRIP	-	380-480V	R1 541,00
CC-24	CLOSING COIL	24-30V	-	R1 856,00
CC-48	CLOSING COIL	48-60V	48-60V	R1 856,00
CC-110	CLOSING COIL	100-130V	100-130V	R1 856,00
CC-240	CLOSING COIL	200-250V	200-250V	R1 856,00
CC-415	CLOSING COIL	-	380-480V	R1 856,00



## AIR CIRCUIT BREAKERS ACCESSORIES

### UNDER VOLTAGE TRIP

Part Number	Voltage		List Price Excl VAT
	DC	AC	
UVT-24	24-30V	-	R2 196,00
UVT-48	48-60V	48-60V	R2 196,00
UVT-110	100-130V	100-130V	R2 196,00
UVT-240	200-250V	200-250V	R2 196,00
UVT-380	-	380-480V	R2 196,00



### MOTOR UNIT

Part Number	Voltage		List Price Excl VAT
	DC	AC	
ACBM-24	24-30V	-	R8 319,00
ACBM-48	48-60V	48-60V	R8 319,00
ACBM-110	100-130V	100-130V	R8 319,00
ACBM-240	200-250V	200-250V	R8 319,00
ACBM-415	-	380-480V	R8 319,00

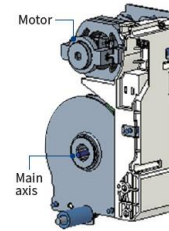

### MECHANICAL INTERLOCK

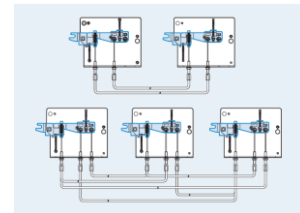

Part Number	Configuration	List Price
		Excl VAT
MI-1	2-BREAKER SET	R14 519,00
MI-3	3-BREAKER SET	R27 188,00

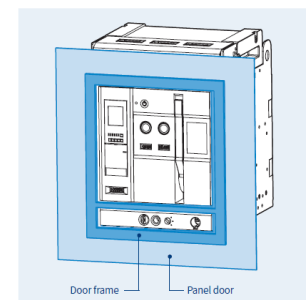

### DOOR FRAMES

Part Number	Configuration	List Price
		Excl VAT
DF-FIXED	FOR FIXED TYPE	R426,00
DF-DRAWOUT	FOR DRAW-OUT TYPE	R426,00



 **Please note:** Countless more accessories available on request, contact us to find out more.  

## Susol ACB

Air Circuit Breaker up to 800 / 900 / 1000 / 1150V



## GMC | GMD MINIATURE CONTACTORS 3-POLE

### GMD MINI CONTACTOR 3-POLE, 1NO, DC COIL

Code	AC3 Amp Rating	AC3 KW Rating	Coil Voltage	List Price
GMD-6M-1A-DC12V	6AMP	2.2KW	DC12V	R380,00
GMD-6M-1A-DC24V			DC24V	
GMD-6M-1A-DC48V			DC48V	
GMD-6M-1A-DC110V			DC110V	
GMD-9M-1A-DC12V	9AMP	4KW	DC12V	R454,00
GMD-9M-1A-DC24V			DC24V	
GMD-9M-1A-DC48V			DC48V	
GMD-9M-1A-DC110V			DC110V	
GMD-12M-1A-DC12V	12AMP	5.5KW	DC12V	R515,00
GMD-12M-1A-DC24V			DC24V	
GMD-12M-1A-DC48V			DC48V	
GMD-12M-1A-DC110V			DC110V	
GMD-16M-1A-DC12V	16AMP	7.5KW	DC12V	R590,00
GMD-16M-1A-DC24V			DC24V	
GMD-16M-1A-DC48V			DC48V	
GMD-16M-1A-DC110V			DC110V	



### GMC MINI CONTACTOR 3-POLE, 1NO, AC COIL

Code	AC3 Amp Rating	AC3 KW Rating	Coil Voltage	List Price
GMC-6M-1A-AC24V	6AMP	2.2KW	AC24V	R325,00
GMC-6M-1A-AC110V			AC110V	
GMC-6M-1A-AC240V			AC240V	
GMC-6M-1A-AC415V			AC415V	
GMC-9M-1A-AC24V	9AMP	4KW	AC24V	R330,00
GMC-9M-1A-AC110V			AC110V	
GMC-9M-1A-AC240V			AC240V	
GMC-9M-1A-AC415V			AC415V	
GMC-12M-1A-AC24V	12AMP	5.5KW	AC24V	R362,00
GMC-12M-1A-AC110V			AC110V	
GMC-12M-1A-AC240V			AC240V	
GMC-12M-1A-AC415V			AC415V	
GMC-16M-1A-AC24V	16AMP	7.5KW	AC24V	R400,00
GMC-16M-1A-AC110V			AC110V	
GMC-16M-1A-AC240V			AC240V	
GMC-16M-1A-AC415V			AC415V	



## GMC & GMD MINI CONTACTOR OVERLOAD

### THERMAL OVERLOAD RELAY FOR GMC|GMD

Code	AC3 Amp Rating	AC3 KW Rating	Setting Range	List Price
GTK-12M-0.21A	0.21A	0.11KW	0.16 - 0.25A	R418,00
GTK-12M-0.33A	0.33A	0.15KW	0.25 - 0.4A	R418,00
GTK-12M-0.52A	0.52A	0.25KW	0.4 - 0.63A	R418,00
GTK-12M-0.82A	0.82A	0.37KW	0.63 - 1A	R418,00
GTK-12M-1.3A	1.3A	0.75KW	1 - 1.6A	R418,00
GTK-12M-2.1A	2.1A	1.1KW	1.6 - 2.5A	R418,00
GTK-12M-3.3A	3.3A	1.5KW	2.5 - 4A	R418,00
GTK-12M-5A	5A	2.2KW	4 - 6A	R418,00
GTK-12M-6.5A	6.5A	3KW	5 - 8A	R418,00
GTK-12M-7.5A	7.5A	3.7KW	6 - 9A	R418,00
GTK-12M-8.5A	8.5A	4KW	7 - 10A	R418,00
GTK-12M-12A	12A	5.5KW	9 - 13A	R418,00
GTK-12M-14A	14A	7.5KW	12 - 16A	R418,00



### GMC | GMD ACCESSORIES

Code	Description	Contacts	List Price
AU-1M-1NO	SIDE MOUNT AUX	1NO	R210,00
AU-1M-1NC		1NC	
AU-2M-2NO		2NO	
AU-2M-1NO1NC		1NO + 1NC	
AU-2M-2NC	FRONT MOUNT AUX	2NC	R260,00
AU-4M-4NO		4NO	
AU-4M-3NO1NC		3NO + 1NC	
AU-4M-2NO2NC		2NO + 2NC	
AU-4M-1NO3NC		1NO + 3NC	
AU-4M-4NC		4NC	
AS-12M-AC24-48V	SURGE SUPPRESSOR, PLUG IN TYPE	AC24-48V	R105,00
AS-12M-AC60-127V		AC60-127V	
AS-12M-AC200-240V		AC200-240V	
AS-12M-DC12-24V		DC12-24V	
AS-12M-DC30-72V		DC30-72V	
AS-12M-DC100-127V		DC100-127V	
AS-12M-DC200-250V		DC200-250V	
AR-12M		MECHANICAL INTERLOCK	
AZ-12MH	SEPARATE MOUNT BASE FOR GTK OVERLOAD		R155,00
COIL-GMC	SPARE COIL FOR GMC AC CONTACTOR		R135,00
COIL-GMD	SPARE COIL FOR GMD DC CONTACTOR		R210,00



## MCT MAGNETIC CONTACTOR 9AMP - 65AMP

### MCT CONTACTOR 3-POLE, 1NO+1NC, AC COIL

Code	AC3 Amp Rating	AC3 KW Rating	Coil Voltage	List Price
MCT9-AC24V	9.0AMP	4.0KW	AC24V	R334,00
MCT9-AC48V			AC48V	
MCT9-AC110V			AC110V	
MCT9-AC240V			AC240V	
MCT9-AC415V			AC415V	
MCT12-AC24V	12AMP	5.5KW	AC24V	R373,00
MCT12-AC48V			AC48V	
MCT12-AC110V			AC110V	
MCT12-AC240V			AC240V	
MCT12-AC415V			AC415V	
MCT18-AC24V	18AMP	7.5KW	AC24V	R486,00
MCT18-AC48V			AC48V	
MCT18-AC110V			AC110V	
MCT18-AC240V			AC240V	
MCT18-AC415V			AC415V	
MCT25-AC24V	25AMP	11KW	AC24V	R650,00
MCT25-AC48V			AC48V	
MCT25-AC110V			AC110V	
MCT25-AC240V			AC240V	
MCT25-AC415V			AC415V	
MCT32-AC24V	32AMP	15KW	AC24V	R691,00
MCT32-AC48V			AC48V	
MCT32-AC110V			AC110V	
MCT32-AC240V			AC240V	
MCT32-AC415V			AC415V	
MCT40-AC24V	40AMP	18.5KW	AC24V	R851,00
MCT40-AC48V			AC48V	
MCT40-AC110V			AC110V	
MCT40-AC240V			AC240V	
MCT40-AC415V			AC415V	
MCT50-AC24V	50AMP	22KW	AC24V	R1 216,00
MCT50-AC48V			AC48V	
MCT50-AC110V			AC110V	
MCT50-AC240V			AC240V	
MCT50-AC415V			AC415V	
MCT65-AC24V	65AMP	30KW	AC24V	R1 457,00
MCT65-AC48V			AC48V	
MCT65-AC110V			AC110V	
MCT65-AC240V			AC240V	
MCT65-AC415V			AC415V	



## MCT MAGNETIC CONTACTOR 75AMP - 330AMP

### MCT CONTACTOR 3-POLE, 1NO+1NC, AC COIL

Code	AC3 Amp Rating	AC3 KW Rating	Coil Voltage	List Price
MCT75-AC24V	75AMP	37KW	AC24V	R1 772,00
MCT75-AC48V			AC48V	
MCT75-AC110V			AC110V	
MCT75-AC240V			AC240V	
MCT75-AC415V			AC415V	
MCT85-AC24V	85AMP	42KW	AC24V	R1 892,00
MCT85-AC48V			AC48V	
MCT85-AC110V			AC110V	
MCT85-AC240V			AC240V	
MCT85-AC415V			AC415V	
MCT100-AC24V	100AMP	45KW	AC24V	R2 862,00
MCT100-AC48V			AC48V	
MCT100-AC110V			AC110V	
MCT100-AC240V			AC240V	
MCT100-AC415V			AC415V	
MCT130-AC/DC24V	130AMP	55KW	AC/DC24V	R3 798,00
MCT130-AC/DC48V			AC/DC48V	
MCT130-AC/DC100-200V			AC/DC100-200V	
MCT130-AC/DC400V			AC/DC400V	
MCT150-AC/DC24V			150AMP	
MCT150-AC/DC48V	AC/DC48V			
MCT150-AC/DC100-200V	AC/DC100-200V			
MCT150-AC400V	AC400V			
MCT185-AC/DC24V	185AMP	90KW		AC/DC24V
MCT185-AC/DC48V			AC/DC48V	
MCT185-AC/DC100-200V			AC/DC100-200V	
MCT185-AC400V			AC400V	
MCT225-AC/DC24V			225AMP	110KW
MCT225-AC/DC48V	AC/DC48V			
MCT225-AC/DC100-200V	AC/DC100-200V			
MCT225-AC400V	AC400V			
MCT265-AC/DC24V	265AMP	132KW		
MCT265-AC/DC48V			AC/DC48V	
MCT265-AC/DC100-200V			AC/DC100-200V	
MCT265-AC400V			AC400V	
MCT330-AC/DC24V			330AMP	160KW
MCT330-AC/DC48V	AC/DC48V			
MCT330-AC/DC100-200V	AC/DC100-200V			
MCT330-AC400V	AC400V			



## MCT MAGNETIC CONTACTOR 400AMP - 800AMP

### MCT CONTACTOR 3-POLE, 1NO+1NC, AC COIL

Code	AC3 Amp Rating	AC3 KW Rating	Coil Voltage	List Price
MCT400-AC/DC24V	400AMP	200KW	AC/DC24V	R11 181,00
MCT400-AC/DC48V			AC/DC48V	
MCT400-AC/DC100-200V			AC/DC100-200V	
MCT400-AC400V			AC400V	
MCT500-AC/DC100V	500AMP	250KW	AC/DC100V	R24 919,00
MCT500-AC/DC200V			AC/DC200V	
MCT500-AC/DC100-240V			AC/DC100-240V	
MCT500-AC400V			AC400V	
MCT630-AC/DC100V	630AMP	300KW	AC/DC100V	R26 763,00
MCT630-AC/DC200V			AC/DC200V	
MCT630-AC/DC100-240V			AC/DC100-240V	
MCT630-AC400V			AC400V	
MCT800-AC/DC100V	800AMP	400KW	AC/DC100V	R29 600,00
MCT800-AC/DC200V			AC/DC200V	
MCT800-AC/DC100-240V			AC/DC100-240V	
MCT800-AC400V			AC400V	



## MCT MAGNETIC CONTACTOR OVERLOAD RELAYS

### THERMAL OVERLOAD RELAY FOR MCT CONTACTOR

Code	AC3 Amp Rating	AC3 KW Rating	Setting Range	List Price
MTT-32-0.14A	0.14A	0.07KW	0.1~0.16	R347,00
MTT-32-0.21A	0.21A	0.1KW	0.16~0.25	R347,00
MTT-32-0.33A	0.33A	0.15KW	0.25~0.4	R347,00
MTT-32-0.52A	0.52A	0.25KW	0.4~0.63	R347,00
MTT-32-0.82A	0.82A	0.37KW	0.63~1	R347,00
MTT-32-1.3A	1.3A	0.55KW	1~1.6	R347,00
MTT-32-2.1A	2.1A	0.75KW	1.6~2.5	R347,00
MTT-32-3.3A	3.3A	1.5KW	2.5~4	R347,00
MTT-32-5A	5A	2.2KW	4~6	R347,00
MTT-32-6.5A	6.5A	3KW	5~8	R347,00
MTT-32-7.5A	7.5A	3.75KW	6~9	R347,00
MTT-32-8.15A	8.15A	4KW	7~10	R347,00
MTT-32-11A	11A	5.5KW	9~13	R347,00
MTT-32-15A	15A	7.5KW	12~18	R347,00
MTT-32-19A	19A	9KW	16~22	R347,00
MTT-32-21.5A	21.5A	11KW	18~25	R347,00
MTT-32-27A	27A	15KW	22~32	R347,00



## MCT MAGNETIC CONTACTOR OVERLOAD RELAYS

### THERMAL OVERLOAD RELAY FOR MCT CONTACTOR

Code	AC3 Amp Rating	AC3 KW Rating	Setting Range	List Price
MTT-40-30A	30A	15KW	24~36	R416,00
MTT-40-34A	34A	18.5KW	28~40	R416,00
MTT-65-42A	42A	22KW	34~50	R628,00
MTT-65-55A	55A	30KW	45~65	R628,00
MTT-85-65A	65A	37KW	54~75	R789,00
MTT-85-74A	74A	40KW	63~85	R789,00
MTT-100-90A	90A	45KW	80~100	R1 110,00
MTT-150-107A 3H	107A	55KW	85~130	R1 970,00
MTT-150-130A 3H	130A	60KW	100~150	R1 970,00
MTT-185-153A 3H	153A	75KW	120~185	R2 463,00
MTT-265-200A 3H	200A	90KW	160~240	R4 178,00
MTT-265-225A 3H	225A	110KW	160~265	R4 178,00
MTT-400-265A 3H	265A	132KW	200~330	R4 683,00
MTT-400-350A 3H	350A	160KW	260~400	R4 683,00
MTT-800-515A 3H	515A	250KW	400~600	R17 337,00
MTT-800-660A 3H	660A	300KW	520~800	R17 337,00



## MCT MAGNETIC CONTACTOR ACCESSORIES

### MCT AUXILIARIES

Code	Description	Contacts	Price
UAT-1-1A	SIDE MOUNT	1A	R131,00
UAT-2-2.2A	FRONT MOUNT	2.2A	R131,00
UAT-2-2.1A1B	FRONT MOUNT	2.1A1B	R131,00
UAT-2-2.2B	FRONT MOUNT	2.2B	R131,00
UST-4-4.4A	FRONT MOUNT	4.4A	R190,00
UST-4-4.3A1B	FRONT MOUNT	4.3A1B	R190,00
UST-4-4.2A2B	FRONT MOUNT	4.2A2B	R190,00
UST-4-4.1A3B	FRONT MOUNT	4.1A3B	R190,00
UST-4-4,4B	FRONT MOUNT	4,4B	R190,00

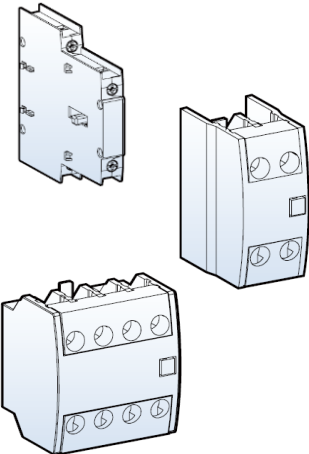

### MCT CONTACTOR ACCESSORIES

Code	Description	Price
UST-2	SURGE ABSORBER AC100-125V	R80,00
UST-3	SURGE ABSORBER AC200-240V	R80,00
UST-13	SURGE ABSORBER AC/DC200-240V	R80,00
TZ	SEPARATE MOUNT BASE FOR MTT OL	R131,00
URT-00	MECHANICAL INTERLOCK MCT9-100	R80,00

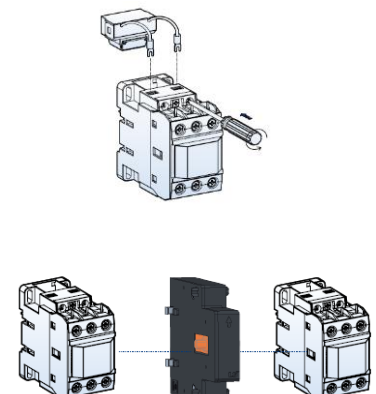

## MC MAGNETIC CONTACTOR, 9AMP -150AMP

### MC CONTACTOR 3-POLE, 1NO+1NC, DC COIL

Code	AC3 Amp Rating	AC3 KW Rating	Coil Voltage	List Price
MC-9B-DC24V	9Amp	4KW	DC24V	R566,00
MC-9B-DC48V			DC48V	
MC-9B-DC110			DC110	
MC-12B-DC24V	12Amp	5.5KW	DC24V	R670,00
MC-12B-DC48V			DC48V	
MC-12B-DC110			DC110	
MC-18B-DC24V	18Amp	7.5KW	DC24V	R911,00
MC-18B-DC48V			DC48V	
MC-18B-DC110			DC110	
MC-22B-DC24V	22Amp	11KW	DC24V	R1 002,00
MC-22B-DC48V			DC48V	
MC-22B-DC110			DC110	
MC-32A-DC24V	32Amp	15KW	DC24V	R1 337,00
MC-32A-DC48V			DC48V	
MC-32A-DC110			DC110	
MC-40A-DC24V	40Amp	18.5KW	DC24V	R1 516,00
MC-40A-DC48V			DC48V	
MC-40A-DC110			DC110	
MC-50A-DC24V	50Amp	22KW	DC24V	R2 055,00
MC-50A-DC48V			DC48V	
MC-50A-DC110			DC110	
MC-65A-DC24V	65Amp	30KW	DC24V	R2 570,00
MC-65A-DC48V			DC48V	
MC-65A-DC110			DC110	
MC-75A-DC24V	75Amp	37KW	DC24V	R3 340,00
MC-75A-DC48V			DC48V	
MC-75A-DC110			DC110	
MC-85A-DC24V	85Amp	45KW	DC24V	R3 955,00
MC-85A-DC48V			DC48V	
MC-85A-DC110			DC110	
MC-100A-DC24V	105Amp	55KW	DC24V	R4 060,00
MC-100A-DC48V			DC48V	
MC-100A-DC110V			DC110V	
MC-130A-DC24V	130Amp	60KW	DC24V	R4 880,00
MC-130A-DC48V			DC48V	
MC-130A-DC110V			DC110V	
MC-150A-DC24V	150Amp	75KW	DC24V	R6 010,00
MC-150A-DC48V			DC48V	
MC-150A-DC110V			DC110V	



## MC MAGNETIC CONTACTOR, 9AMP - 65AMP

### MC CONTACTOR 4-POLE, AC COIL

Code	AC3 Amp Rating	AC3 KW Rating	Coil Voltage	List Price
MC-9A-4-AC24V	9Amp	4KW	AC24V	R489,00
MC-9A-4-AC48V			AC48V	
MC-9A-4-AC110V			AC110V	
MC-9A-4-AC240V			AC240V	
MC-9A-4-AC415V			AC415V	
MC-12A-4-AC24V	12Amp	5.5KW	AC24V	R541,00
MC-12A-4-AC48V			AC48V	
MC-12A-4-AC110V			AC110V	
MC-12A-4-AC240V			AC240V	
MC-12A-4-AC415V			AC415V	
MC-18A-4-AC24V	18Amp	7.5KW	AC24V	R721,00
MC-18A-4-AC48V			AC48V	
MC-18A-4-AC110V			AC110V	
MC-18A-4-AC240V			AC240V	
MC-18A-4-AC415V			AC415V	
MC-22A-4-AC24V	22Amp	11KW	AC24V	R850,00
MC-22A-4-AC48V			AC48V	
MC-22A-4-AC110V			AC110V	
MC-22A-4-AC240V			AC240V	
MC-22A-4-AC415V			AC415V	
MC-32A-4-AC24V	32Amp	15KW	AC24V	R1 280,00
MC-32A-4-AC48V			AC48V	
MC-32A-4-AC110V			AC110V	
MC-32A-4-AC240V			AC240V	
MC-32A-4-AC415V			AC415V	
MC-40A-4-AC24V	40Amp	18.5KW	AC24V	R1 491,00
MC-40A-4-AC48V			AC48V	
MC-40A-4-AC110V			AC110V	
MC-40A-4-AC240V			AC240V	
MC-40A-4-AC415V			AC415V	
MC-50A-4-AC24V	50Amp	22KW	AC24V	R2 315,00
MC-50A-4-AC48V			AC48V	
MC-50A-4-AC110V			AC110V	
MC-50A-4-AC240V			AC240V	
MC-50A-4-AC415V			AC415V	
MC-65A-4-AC24V	65Amp	30KW	AC24V	R2 697,00
MC-65A-4-AC48V			AC48V	
MC-65A-4-AC110V			AC110V	
MC-65A-4-AC240V			AC240V	
MC-65A-4-AC415V			AC415V	



## MC MAGNETIC CONTACTOR, 75AMP-500AMP

### MC CONTACTOR 4-POLE, AC COIL

Code	AC3 Amp Rating	AC3 KW Rating	Coil Voltage	List Price
MC-75A-4-AC24V	75Amp	37KW	AC24V	R3 472,00
MC-75A-4-AC48V			AC48V	
MC-75A-4-AC110V			AC110V	
MC-75A-4-AC240V			AC240V	
MC-75A-4-AC415V			AC415V	
MC-85A-4-AC24V	85Amp	45KW	AC24V	R3 785,00
MC-85A-4-AC48V			AC48V	
MC-85A-4-AC110V			AC110V	
MC-85A-4-AC240V			AC240V	
MC-85A-4-AC415V			AC415V	
MC-100A-4-AC24V	105Amp	55KW	AC24V	R6 784,00
MC-100A-4-AC48V			AC48V	
MC-100A-4-AC110V			AC110V	
MC-100A-4-AC240V			AC240V	
MC-100A-4-AC415V			AC415V	
MC-130A-4-AC110V	120Amp	60KW	AC110V	R7 775,00
MC-130A-4-AC240V			AC240V	
MC-130A-4-AC415V			AC415V	
MC-150A-4-AC110V	150Amp	75KW	AC110V	R9 070,00
MC-150A-4-AC240V			AC240V	
MC-150A-4-AC415V			AC415V	
MC-185A-4-AC110V	185Amp	90KW	AC110V	R9 848,00
MC-185A-4-AC240V			AC240V	
MC-185A-4-AC415V			AC415V	
MC-225A-4-AC110V	225Amp	132KW	AC110V	R11 402,00
MC-225A-4-AC240V			AC240V	
MC-225A-4-AC415V			AC415V	
MC-265A-4-AC110V	265Amp	147KW	AC110V	R18 140,00
MC-265A-4-AC240V			AC240V	
MC-265A-4-AC415V			AC415V	
MC-330A-4-AC110V	330Amp	160KW	AC110V	R19 695,00
MC-330A-4-AC240V			AC240V	
MC-330A-4-AC415V			AC415V	
MC-400A-4-AC110V	400Amp	200KW	AC110V	R21 245,00
MC-400A-4-AC240V			AC240V	
MC-400A-4-AC415V			AC415V	
MC-500A-4-AC110V	500Amp	250KW	AC110V	R33 685,00
MC-500A-4-AC240V			AC240V	
MC-500A-4-AC415V			AC415V	



## MC MAGNETIC CONTACTOR, OVERLOAD RELAYS

### THERMAL OVERLOAD RELAY FOR MC-9 TO MC-40

Code	AC3 Amp Rating	AC3 KW Rating	Setting Range	List Price
MT-32-3K-0.14A	0.14A	0.07KW	0.1 - 0.16A	R727,00
MT-32-3K-0.21A	0.21A	0.1KW	0.16 - 0.25A	R727,00
MT-32-3K-0.33A	0.33A	0.15KW	0.25 - 0.4A	R727,00
MT-32-3K-0.52A	0.52A	0.25KW	0.4 - 0.63A	R727,00
MT-32-3K-0.82A	0.82A	0.37KW	0.63 - 1A	R727,00
MT-32-3K-1.3A	1.3A	0.55KW	1 - 1.6A	R727,00
MT-32-3K-2.1A	2.1A	0.75KW	1.6 - 2.5A	R727,00
MT-32-3K-3.3A	3.3A	1.5KW	2.5 - 4A	R727,00
MT-32-3K-5A	5A	2.2KW	4 - 6A	R727,00
MT-32-3K-6.5A	6.5A	3KW	5 - 8A	R727,00
MT-32-3K-7.5A	7.5A	3.75KW	6 - 9A	R727,00
MT-32-3K-8.5A	8.5A	4KW	7 - 10A	R727,00
MT-32-3K-11A	11A	5.5KW	9 - 13A	R727,00
MT-32-3K-15A	15A	7.5KW	12 - 18A	R727,00
MT-32-3K-19A	19A	9KW	16 - 22A	R727,00
MT-32-3K-21.5A	21.5A	11KW	18 - 25A	R727,00
MT-32-3K-27A	27A	15KW	22 - 32A	R727,00
MT-32-3K-34A	34A	18.5KW	28 - 40A	R727,00



### THERMAL OVERLOAD RELAY FOR MC-50 TO MC-65

MT-63-3K-42A	42A	22KW	34-50A	R1 194,00
MT-63-3K-54A	54A	30KW	46-65A	R1 194,00

### THERMAL OVERLOAD RELAY FOR MC-75 TO MC-100

MT-95-3K-65A	65A	37KW	54 - 75A	R1 867,00
MT-95-3K-74A	74A	40KW	63 - 85A	R1 867,00
MT-95-3K-83A	83A	45KW	70 - 95A	R1 867,00
MT-95-3K-90A	90A	55KW	80 - 100A	R1 867,00

### THERMAL OVERLOAD RELAY FOR MC-75 TO MC-100

MT-150-3D-93A	93A	55KW	80 - 100A	R2 593,00
MT-150-3D-113A	113A	60KW	95 - 130A	R2 593,00
MT-150-3D-130A	130A	65KW	110 - 150A	R2 593,00

### THERMAL OVERLOAD RELAY FOR MC-185 TO MC-225

MT-225-3D-150A	150A	75KW	120 - 180A	R4 405,00
MT-225-3D-200A	200A	90KW	160 - 240A	R4 405,00

### THERMAL OVERLOAD RELAY FOR MC-265 TO MC-400

MT-400 -3D-265A	265A	132KW	200 - 330A	R6 220,00
MT-400 -3D-350A	350A	150KW	260 - 400A	R6 220,00

### THERMAL OVERLOAD RELAY FOR MC-500 TO MC-800

MT-800-3D-515A	515A	250KW	400 - 600A	R12 440,00
MT-800-3D-660A	660A	315KW	520 - 800A	R12 440,00



## MC MAGNETIC CONTACTOR, ACCESSORIES

### MC CONTACTOR AUXILIARIES

Code	For	Contacts	List Price
UA-1-1NO1NC	MC-9-150	1NO+1NC	R110,00
UA-2-2NO	MC-9-150	2NO	R110,00
UA-2-2NC	MC-9-150	2NC	R110,00
UA-4-4NO	MC-9-150	4NO	R180,00
UA-4-3NO+1NC	MC-9-150	3NO+1NC	R180,00
UA-4-2NO+2NC	MC-9-150	2NO+2NC	R180,00
UA-4-1NO+3NC	MC-9-150	1NO+3NC	R180,00
UA-4-4NC	MC-9-150	4NC	R180,00
AU-100E-1NO + 1NC	MC-185-800	1NO+1NC	R250,00

### MC CONTACTOR PNEUMATIC TIMER

UN-2N	0.1-30SEC	1NO+1NC	R910,00
UN-2F	0.1-30SEC	1NO+1NC	R910,00

### MC CONTACTOR MECHANICAL

UR-02	MC-9-150	3-POLE MC	R250,00
AR-9	MC-22-85	4-POLE MC	POR
AR180	MC-185-400	3-POLE MC	R780,00
AR180	MC-100-400	4-POLE MC	R780,00
AR-600H	MC-500-800	HORIZONTAL	R12 000,00
AR-600V	MC-500-800	VERTICAL	R12 000,00

### MC CONTACTOR COIL SURGE UNIT

US-13-120V	120V	AC/DC 24-48V	R165,00
US-13-270V	270V	AC/DC 100-120V	R165,00
US-13-470V	470V	AC/DC 200-240V	R165,00
US-13-1000V	1000V	AC/DC 380-440V	R165,00

### MC CONTACTOR CAPACITOR UNIT

AC-9	MC-9B-40A	R450,00
AC-50	MC-50A-100A	R600,00

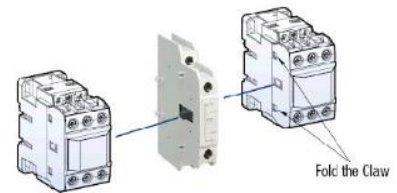

## MT OVERLOAD RELAY ACCESSORIES

### MT SEPARATE MOUNTING BASE FOR

UZ-32-	MT-32	R130,00
UZ-63-	MT-63	R160,00
UZ-95-	MT-95	R200,00
UZ-150-	MT-150	R350,00



## MMS MOTOR PROTECTION CIRCUIT BREAKERS

### MMS ROTARY TYPE MANUAL MOTOR STARTER

Part Number	Range (A)	ICU/KA	AC415V	List Price
MMS-32H-0.08KW	0.1-0.16A	100kA	0.08KW	R995,00
MMS-32H-0.13KW	0.16-0.25A	100kA	0.13KW	R995,00
MMS-32H-0.18KW	0.25-0.4A	100kA	0.18KW	R995,00
MMS-32H-0.2KW	0.4-0.63A	100kA	0.2KW	R995,00
MMS-32H-0.35KW	0.63-1.0A	100kA	0.35KW	R995,00
MMS-32H-0.55KW	1.0-1.6A	100kA	0.55KW	R995,00
MMS-32H-0.75KW	1.6-2.5A	100kA	0.75KW	R995,00
MMS-32H-1.5KW	2.5-4.0A	100kA	1.5KW	R995,00
MMS-32H-2.2KW	4.0-6.0A	100kA	2.2KW	R995,00
MMS-32H-3.0KW	5.0-8.0A	100kA	3.0KW	R995,00
MMS-32H-4KW	6.0-10A	100kA	4KW	R995,00
MMS-32H-5.5KW	9.0-13A	100kA	5.5KW	R1 075,00
MMS-32H-7.5KW	11-17A	50KA	7.5KW	R1 075,00
MMS-32H-10KW	14-22A	50KA	10KW	R1 075,00
MMS-32H-11KW	18-26A	50KA	11KW	R1 075,00
MMS-32H-15KW	22-32A	50KA	15KW	R1 075,00
MMS-63S-18.5KW	28-40A	25KA	18.5KW	R2 171,00
MMS-63S-22KW	34-50A	25KA	22KW	R2 293,00
MMS-63S-30KW	45-63A	25KA	30KW	R2 293,00
MMS-100-37KW	55-75A	50KA	37KW	R4 144,00
MMS-100-45KW	70-90A	50KA	45KW	R4 485,00
MMS-100-55KW	80-100A	50KA	55KW	R4 485,00



## MMS ACCESSORIES

### MMS AUXILIARIES

Part Number	Type	Contacts	List Price
FX-2A	FRONT MOUNT	2A	R222,00
FX-1A1B	FRONT MOUNT	1A1B	R222,00
FX-2B	FRONT MOUNT	2B	R222,00
LX-2A	SIDE MOUNT	2A	R258,00
LX-1A1B	SIDE MOUNT	1A1B	R258,00
LX-2B	SIDE MOUNT	2B	R258,00
LA-2A	ANY TRIP ALARM, 32	2A	R336,00
LA-1A1B	ANY TRIP ALARM, 33	1A1B	R336,00
LA-2B	ANY TRIP ALARM, 34	2B	R336,00
LA-2A-63	ANY TRIP ALARM, 63/100	2A	R336,00
LA-1A1B-63	ANY TRIP ALARM, 63/101	1A1B	R336,00
LA-2B-63	ANY TRIP ALARM, 63/102	2B	R336,00
LAM-2A	MAGNETIC TRIP ALARM	2A	R357,00
LAM-1A1B	MAGNETIC TRIP ALARM	1A1B	R357,00
LAM-2B	MAGNETIC TRIP ALARM	2B	R357,00



### MMS UNDER VOLTAGE TRIP

Part Number	Type	Contacts	List Price
RUX-AC24V	UVT	AC24V	R639,00
RUX-AC110V	UVT	AC110V	R639,00
RUX-AC240V	UVT	AC240V	R639,00
RUX-AC415V	UVT	AC415V	R639,00

## MMS ACCESSORIES

### MMS EXTENDED HANDLE

Part Number	Type	For	List Price
MEH-32	DOOR INTERLOCK HANDLE	MMS-32	R671,00
MEH-63	DOOR INTERLOCK HANDLE	MMS-63	R671,00
MEH-100	DOOR INTERLOCK HANDLE	MMS-100	R671,00

### MMS ENCLOSURE

Part Number	Type	For	List Price
EPH-32	IP65, SURFACE MOUNT	MMS-32	R510,00

### MMS BUSBAR COMB

Part Number	Type	For	List Price
PB-322	2-WAY	MMS-32	POR
PB-323	3-WAY	MMS-33	POR
PB-325	5-WAY	MMS-34	POR

### MMS BASE MOUNT UNIT

Part Number	Type	For	List Price
DA-16HA	DIRECT ADAPTOR	MMS-32	POR
DA-32HA	DIRECT ADAPTOR	MMS-32	POR
DA-63A	DIRECT ADAPTOR	MMS-63	POR
DA-95A	DIRECT ADAPTOR	MMS-63	POR
MU-45	MOUNTING BASE	MMS-32	POR
MU-55	MOUNTING BASE	MMS-63	POR
MU-70	MOUNTING BASE	MMS-100	POR



### MMS-32H, 32HI

- 1) Side auxiliary switch
- 2) Side magnetic trip alarm switch
- 3) Side shunt release or side undervoltage release
- 4) Front auxiliary switch
- 5) Handle lock in Off position(Ø5mm)
- 6) Push-in lugs for screw mounting
- 7) 35mm standard mounting rail acc. to EN 50 022

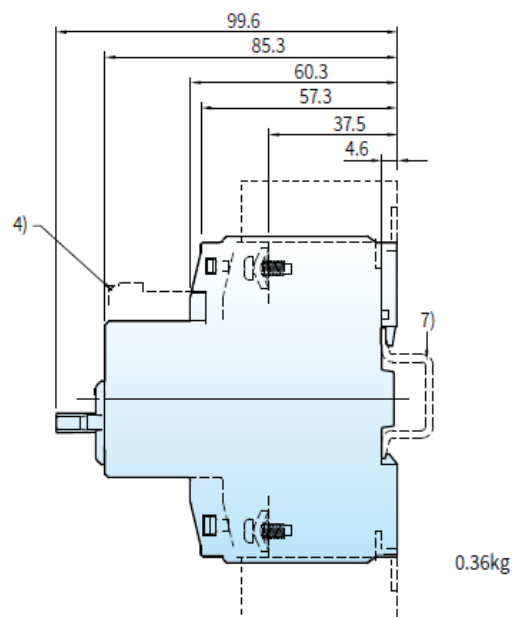
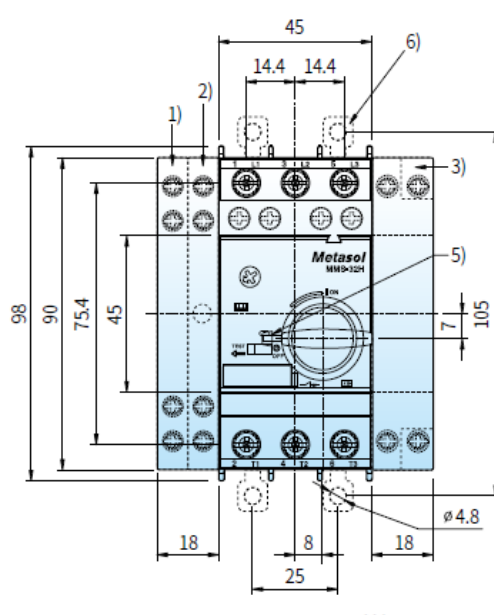

## ISOLATORS 16AMP - 630AMP, AC23 RATED

### 4-POLE PANEL MOUNT AC380/690VAC

Code	Description	List Price
GLD-11-16-4P	ISOLATOR SIDE MOUNT 16A 4P	R330.00
GLD-11-25-4P	ISOLATOR SIDE MOUNT 25A 4P	R355.00
GLD-11-32-4P	ISOLATOR SIDE MOUNT 32A 4P	R390.00
GLD-11-40-4P	ISOLATOR SIDE MOUNT 40A 4P	R428.00
GLD-11-63-4P	ISOLATOR SIDE MOUNT 63A 4P	R490.00
GLD-11-80-4P	ISOLATOR SIDE MOUNT 80A 4P	R640.00
GLD-11-100-4P	ISOLATOR SIDE MOUNT 100A 4P	R672.00



### 3-POLE ENCLOSED ISOLATOR AC380/690V

Code	Description	List Price
GLD-12-16	ENCLOSED ISOLATOR 16AMP 3P	R367.00
GLD-12-20	ENCLOSED ISOLATOR 20AMP 3P	R400.00
GLD-12-25	ENCLOSED ISOLATOR 25AMP 3P	R450.00
GLD-12-32	ENCLOSED ISOLATOR 32AMP 3P	R496.00
GLD-12-40	ENCLOSED ISOLATOR 40AMP 3P	R590.00
GLD-12-63	ENCLOSED ISOLATOR 63AMP 3P	R820.00
GLD-12-80	ENCLOSED ISOLATOR 80AMP 3P	R940.00
GLD-12-100	ENCLOSED ISOLATOR 100AMP 3P	R1 080.00



### 4-POLE DIN RAIL MOUNT AC

Code	Description	List Price
EKD6-LK40-4RY	ISOLATED SWITCH AC 4P 40A RED HANDLE	POR

### DIN RAIL MOUNT DC

Code	Description	List Price
EKD6-DB32-2	ISOLATOR DC 2P 32A 2 SERIES	POR
EKD6-DB32-4	ISOLATOR DC 4P 32A 4 SERIES	POR



### BASE MOUNT LOAD BREAK SWITCH

Code	Description	List Price
EKCG1-160/4	LOAD BREAK SWITCH 4P – 160A	POR
EKCG1-250/4	LOAD BREAK SWITCH 4P – 250A	POR
EKCG1-400/4	LOAD BREAK SWITCH 4P – 400A	POR
EKCG1-630/4	LOAD BREAK SWITCH 4P – 630A	POR



#### Why Use a Rotary Type Isolator with a Lockable Handle?

- Enhanced Safety** – Allows complete disconnection of power for maintenance or emergencies.
- Lockout/Tagout Ready** – Prevents accidental re-energizing during servicing, meeting safety standards.
- Clear Visual Status** – Handle position clearly shows ON/OFF status, reducing operational mistakes.
- Tamper Resistance** – Lockable handle helps avoid unauthorized operation.
- Durable and Rugged** – Designed to withstand industrial environments, indoors or outdoors.
- Space Efficient** – Wall or panel mountable, saving space compared to larger isolating systems.
- Reliable Operation** – Provides a positive break in all poles, ensuring true isolation.

## STANDARD SOFT STARTER

- Ultra compact design (Built-in bypass)
- IEC/UL/KC Standards
- Built-in motor protection
- Allows for fast diagnosis of a trip via two LEDs
- Simple panel configuration & cost-saving
- Easy operation & control



### SSCI SOFTSTART, 7.5KW-132KW, AC200-575V, AC/DC24V CONTROL

Part Number	Rated Current	Normal Duty	Heavy Duty	Normal Duty	Heavy Duty	List Price
		AC380V	AC380V	AC525V	AC525V	
SSCi-018-V6-C2	18 AMP	11 KW	7.5 KW	15 KW	11 KW	R15 199,00
SSCi-034-V6-C2	34 AMP	15 KW	11 KW	18.5 KW	15 KW	R15 974,00
SSCi-042-V6-C2,	42 AMP	18.5 KW	15KW	22 KW	18.5 KW	R17 184,00
SSCi-048-V6-C2	48 AMP	22 KW	18.5 KW	30 KW	22 KW	R18 912,00
SSCi-060-V6-C2	60 AMP	30 KW	22 KW	37 KW	30 KW	R20 035,00
SSCi-075-V6-C2	75 AMP	37 KW	30 KW	45 KW	37 KW	R24 180,00
SSCi-085-V6-C2	85 AMP	45KW	37 KW	55 KW	45 KW	R27 460,00
SSCi-100-V6-C2	100 AMP	55 KW	45 KW	75 KW	55 KW	R29 532,00
SSCi-140-V6-C2	140 AMP	75 KW	55 KW	90 KW	75 KW	R34 022,00
SSCi-170-V6-C2	170 AMP	90 KW	75 KW	110KW	90 KW	R38 167,00
SSCi-200-V6-C2	200 AMP	110KW	90 KW	132 KW	110 KW	R41 795,00

### SSCI SOFTSTART, OPTIONS

Part Number	Description	List Price
6B090001	DeviceNet INTERFACE CARD FOR SSCI	R10 361,00
6B090003	Ethernet IP INTERFCE CARD FOR SSCI	R13 384,00
6B090008	MODBUS TCP INTERFACE CARD FOR SSCI	R13 384,00
6B090009	MODBUS INTERFACE CARD FOR SSCI	R6 390,00
6B090012	PROFIBUS INTERFACE CARD FOR SSCI	R13 816,00
6B090014	PROFINET INTERFACE CARD FOR SSCI	R13 364,00
6B090016	REMOTE OPERATOR AND INTERFACE KIT FOR SSCI	R14 422,00

## ADVANCED SOFT STARTER

- Compact design with integrated bypass for seamless panel integration
- Conforms to IEC/UL/KC standards for global compliance
- Full motor protection: overload, under/over-voltage, imbalance, over-frequency.
- 2-phase control option for continued operation under single SCR fault.
- Graphical display & wide voltage range (200–690 VAC, 24–1250 A).



### SSMI SOFTSTART, 7.5KW-900KW, AC200-575V, AC/DC24V CONTROL

Part Number	Rated Current	Normal Duty		Heavy Duty		List Price
		AC380V	AC380V	AC525V	AC525V	
SSMi-0024B-V7-C2	24 AMP	11KW	7.5KW	15KW	11KW	R25 561,00
SSMi-0042B-V7-C2	42 AMP	18.5KW	15KW	22KW	15KW	R26 251,00
SSMi-0052B-V7-C2	52 AMP	22KW	18.5KW	30KW	22KW	R27 806,00
SSMi-0064B-V7-C2	64 AMP	30KW	22KW	37KW	30KW	R29 706,00
SSMi-0069B-V7-C2	69 AMP	37KW	30KW	45KW	37KW	R31 432,00
SSMi-0105B-V7-C2	105 AMP	45KW	37KW	55KW	45KW	R42 054,00
SSMi-0115B-V7-C2	115 AMP	55KW	45KW	60KW	55KW	R48 444,00
SSMi-0135B-V7-C2	135 AMP	60KW	55KW	75KW	60KW	R57 511,00
SSMi-0184B-V7-C2	184 AMP	75KW	60KW	90KW	75KW	R62 173,00
SSMi-0200B-V7-C2	200 AMP	90KW	75KW	110KW	90KW	R66 060,00
SSMi-0229B-V7-C2	229 AMP	110KW	90KW	132KW	110KW	R77 630,00
SSMi-0250B-V7-C2	250 AMP	132KW	110KW	160KW	132KW	R91 533,00
SSMi-0352B-V7-C2	352 AMP	160KW	132KW	185KW	160KW	R106 042,00
SSMi-0397B-V7-C2	397 AMP	185KW	150KW	220KW	185KW	R118 390,00
SSMi-0410B-V7-C2	410 AMP	220KW	200KW	280KW	220KW	R139 115,00
SSMi-0550B-V7-C2	550 AMP	300KW	220KW	255KW	280KW	R165 883,00
SSMi-0580B-V7-C2	580 AMP	315KW	250KW	400KW	355KW	R186 350,00
SSMi-0835B-V7-C2	835 AMP	355KW	300KW	450KW	400KW	R215 697,00
SSMi-0940B-V7-C2	940 AMP	400KW	315KW	500KW	450KW	R266 570,00
SSMi-1070B-V7-C2	1070 AMP	500KW	450KW	600KW	500KW	R305 343,00
SSMi-1230B-V7-C2	1230 AMP	600KW	500KW	800KW	600KW	R340 575,00
SSMi-1250B-V7-C2	1250 AMP	700KW	600KW	900KW	800KW	R415 789,00

## SSMI SOFTSTART, OPTIONS

Part Number	Description	List Price
6B090002	DeviceNet INTERFACE CARD FOR SSMI	R10 361,00
6B090004	Ethernet IP INTERFCE CARD FOR SSMI	R11 571,00
6B090010	MODBUS TCP INTERFACE CARD FOR SSMI	R11 571,00
6B090011	MODBUS RTU INTERFACE CARD FOR SSMI	R3 542,00
6B090013	PROFIBUS INTERFACE CARD FOR SSMI	R13 816,00
6B090015	PROFINET INTERFACE CARD FOR SSMI	R11 571,00
6B090021	REMOTE OPERATOR AND INTERFACE KIT FOR SSMI	R5 787,00



## ECONOMY SOFT STARTER

### GW3 SERIES ONLINE AC380V 3-PHASE

Part Number	Rated Current	Rated Power	Nett Price
GW3-011	22AMP	11 KW	R8 200,00
GW3-015	30AMP	15KW	R8 400,00
GW3-018	37AMP	18.5KW	R8 605,00
GW3-022	44AMP	22KW	R9 500,00
GW3-030	60AMP	30KW	R10 100,00
GW3-037	75AMP	37KW	R11 450,00
GW3-045	90AMP	45KW	R12 550,00
GW3-055	110AMP	55KW	R13 672,00
GW3-075	150AMP	75KW	R17 806,00
GW3-090	180AMP	90KW	R20 605,00
GW3-115	230AMP	115KW	R24 391,00
GW3-132	264AMP	132KW	R35 300,00
GW3-160	320AMP	160KW	R36 600,00
GW3-200	400AMP	200KW	R47 850,00
GW3-250	500AMP	250KW	R52 185,00
GW3-280	560AMP	280KW	R5 500,00
GW3-315	630AMP	315KW	R59 600,00
GW3-355	710AMP	355KW	R68 100,00



#### **Tech Tip: Soft Starter or VSD?**

Choosing between a **Soft Starter** and a **Variable Speed Drive (VSD)** depends on your application needs.

 Use a **Soft Starter** when you only need **reduced starting current** and **basic motor protection** — ideal for fans, pumps, and conveyors running at constant speed.

 Choose a **VSD** when you need **speed control**, **energy savings**, or **torque management** — perfect for dynamic loads and process control.

 **Tip:** If your load doesn't need variable speed, a soft starter is often the more cost-effective choice.

## 900E Series Smart Pump VSD

The 900E Series Smart Pump Inverter is centered on intelligence and high-efficiency energy savings, leveraging precise closed-loop pressure-flow control and IoT technology to redefine the operational efficiency and management of



### 900E 0.75KW - 1.5KW AC200~240V±10% 150% 60s

Part Number	Power	Output Amp	Voltage	WxHxD (mm)	Protection	List Price
M900-0007E1	0.75KW	4.0AMP	AC200~240V±10%	86x153x106	IP20	R1 780,00
M900-0015E1	1.5KW	7.0AMP	AC200~240V±10%	86x153x106	IP20	R1 890,00

### 900E 0.75KW - 2.2KW AC380~480V±10%, 150% 60s

Part Number	Power	Output Amp	Voltage	WxHxD (mm)	Protection	List Price
M900-0007E3	0.75KW	2.5AMP	AC380~480V±10%	86x153x106	IP20	R2 400,00
M900-0015E3	1.5KW	3.7AMP	AC380~480V±10%	86x153x106	IP20	R2 500,00
M900-0022E3	2.2KW	5.1AMP	AC380~480V±10%	86x153x106	IP20	R2 600,00

## 900M Series Smart Mini VSD

- Open Loop Vector Control (SVC) ; V/F Control
- Multi Speed running (8 Segments)
- Built-in PID
- Over voltage, Over Current and Stall protection
- Motor Over Temperature Control
- Modbus
- 4 Digital Input, 2 Analog Input



### 900M 0.75KW - 1.5KW AC200~240V±10%, 150% 60s

Part Number	Power	Output Amp	Voltage	WxHxD (mm)	Protection	List Price
M900-0007M1	0.75KW	4.0AMP	AC200~240V±10%	86x153x123	IP20	R2 200,00
M900-0015M1	1.5KW	7.0AMP	AC200~240V±10%	86x153x123	IP20	R2 380,00

### 900M 0.75KW - 2.2KW AC380~480V±10%, 150% 60s

Part Number	Power	Output Amp	Voltage	WxHxD (mm)	Protection	List Price
M900-0007M3	0.75KW	2.5AMP	AC380~480V±10%	86x153x123	IP20	R2 650,00
M900-0015M3	1.5KW	3.7AMP	AC380~480V±10%	86x153x123	IP20	R2 780,00
M900-0022M3	2.2KW	5.1AMP	AC380~480V±10%	86x153x123	IP20	R3 050,00

## 900G Series Smart VSD

- Open Loop Vector Control (SVC) ; V/F Control
- Multi Speed running (8 Segments)
- Built-in PID
- Over voltage, Over Current and Stall protection
- Motor Over Temperature Control
- Modbus
- 5 Digital Inputs, 2 Analog Inputs
- 2 Relay Output, 2 Collector Output, 2 Analog Output



### 900 0.75KW - 5.5KW AC200~240V±10%, 150% 60s, 180% 3s

Part Number	Power	Output Amp	Voltage	WxHxD (mm)	Protection	List Price
M900-0007G1	0.75KW	4.0AMP	AC200~240V±10%	86x170x141	IP20	R2 630,00
M900-0015G1	1.5KW	7.0AMP	AC200~240V±10%	86x170x141	IP20	R2 820,00
M900-0022G1	2.2KW	10AMP	AC200~240V±10%	86x170x141	IP20	R3 350,00
M900-0040G1	4.0KW	13AMP	AC200~240V±10%	96x188x171	IP20	R5 680,00
M900-0055G1	5.5KW	25AMP	AC200~240V±10%	96x188x171	IP20	R7 150,00

### 900M 0.75KW - 400KW AC380~480V±10%, 150% 60s, 180% 3s

Part Number	Power	Output Amp	Voltage	WxHxD (mm)	Protection	List Price
M900-0007G3	0.75KW	2.5AMP	AC380~480V±10%	86x170x141	IP20	R3 400,00
M900-0015G3	1.5KW	3.7AMP	AC380~480V±10%	86x170x141	IP20	R3 540,00
M900-0022G3	2.2KW	5.1AMP	AC380~480V±10%	86x170x141	IP20	R3 720,00
M900-0040G3	4.0KW	8.5AMP	AC380~480V±10%	96x188x171	IP20	R4 950,00
M900-0055G3	5.5KW	13AMP	AC380~480V±10%	96x188x171	IP20	R6 840,00
M900-0075G3	7.5KW	16AMP	AC380~480V±10%	114x228x192	IP20	R7 910,00
M900-0110G3	11KW	25AMP	AC380~480V±10%	114x228x192	IP20	R11 970,00
M900-0150G3	15KW	32AMP	AC380~480V±10%	160x290x182	IP20	R12 840,00
M900-0185G3	18.5KW	38AMP	AC380~480V±10%	160x290x182	IP20	R15 030,00
M900-0220G3	22KW	45AMP	AC380~480V±10%	193x328x217	IP20	R16 900,00
M900-0300G3	30KW	60AMP	AC380~480V±10%	193x328x217	IP20	R26 496,00
M900-0370G3	37KW	75AMP	AC380~480V±10%	228x344x223	IP20	R32 223,00
M900-0450G3	45KW	90AMP	AC380~480V±10%	228x344x223	IP20	R40 752,00
M900-0550G3	55KW	110AMP	AC380~480V±10%	327.5x490x238	IP20	R48 344,00
M900-0750G3	75KW	150AMP	AC380~480V±10%	300x528x279	IP20	R57 312,00
M900-0930G3	93KW	170AMP	AC380~480V±10%	300x528x279	IP20	R64 944,00
M900-1100G3	110KW	210AMP	AC380~480V±10%	370x690x360	IP20	R78 980,00
M900-1320G3	132KW	250AMP	AC380~480V±10%	370x690x360	IP20	R98 544,00
M900-1600G3	160KW	300AMP	AC380~480V±10%	428x724x358.5	IP20	R121 032,00
M900-1850G3	185KW	340AMP	AC380~480V±10%	428x724x358.5	IP20	R137 592,00
M900-2000G3	200KW	380AMP	AC380~480V±10%	453x794x358.5	IP20	R140 112,00
M900-2200G3	220KW	415AMP	AC380~480V±10%	453x794x358.5	IP20	R150 336,00
M900-2500G3	250KW	470AMP	AC380~480V±10%	650x1060x392.5	IP20	R226 512,00
M900-2800G3	280KW	520AMP	AC380~480V±10%	650x1060x392.5	IP20	R230 544,00
M900-3150G3	315KW	600AMP	AC380~480V±10%	650x1060x392.5	IP20	R244 584,00
M900-3500G3	355KW	650AMP	AC380~480V±10%	818x1362x405	IP20	R347 760,00
M900-4000G3	400KW	725AMP	AC380~480V±10%	818x1362x405	IP20	R363 024,00

### 900-M AC220V SINGLE PHASE TO AC380V THREE PHASE

Part Number	Power	Output Amp	Input Amps	WxHxD (mm)	Protection	List Price
M900-M0040G1	4.0	8.5AMP	34Amp	114x228x192	IP20	R6 940,00
M900-M0055G1	5.5	13AMP	52Amp	114x228x192	IP20	R7 830,00

## M980 IP66 High-Ingress Protection

M980 IP66 VFD is our newly developed high-performance compact inverter. Featuring an optimized structural design, this product offers a more compact size, sleeker appearance, user-friendly operation, and comprehensive functionality. With exceptional reliability and broad adaptability to various operating conditions, it ensures robust performance in diverse industrial environments.



### M980 S-TYPE 0.75KW - 1.5KW AC200~240V±10%, 150% 60s, 180% 3s

Part Number	Power	Output Amp	Voltage	Dimensions	Protection	List Price
M980-0007S1	0.75KW	4.0AMP	AC200~240V±10%	146x162x72	IP66	R4 430,00
M980-0015S1	1.5KW	7.0AMP	AC200~240V±10%	146x162x72	IP66	R4 940,00

### M980 S-TYPE 0.75KW - 2.2KW AC380~480V±10%, 150% 60s, 180% 3s

Part Number	Power	Output Amp	Voltage	Dimensions	Protection	List Price
M980-0007S3	0.75KW	4.0AMP	AC380~480V±10%	146x162x72	IP66	R4 430,00
M980-0015S3	1.5KW	7.0AMP	AC380~480V±10%	146x162x72	IP66	R4 940,00
M980-0022S3	2.2KW	10AMP	AC380~480V±10%	146x162x72	IP66	R6 000,00

### M980 G-TYPE 2.2KW-15KW AC380~480V±10%+ EMC FILTER

Part Number	Power	Output Amp	Voltage	Dimensions	Protection	List Price
M980-0022G3	2.2KW	5.1AMP	AC380~480V±10%	256x127x156	IP66	R6 952,00
M980-0040G3	4.0KW	9.0AMP	AC380~480V±10%	256x127x156	IP66	R7 900,00
M980-0055G3	5.5KW	13AMP	AC380~480V±10%	286x155x174	IP66	R9 350,00
M980-0075G3	7.5KW	16AMP	AC380~480V±10%	286x155x174	IP66	R10 710,00
M980-0110G3	11KW	25AMP	AC380~480V±10%	286x155x174	IP66	R15 645,00
M980-0150G3	15KW	32AMP	AC380~480V±10%	286x155x174	IP66	R17 420,00

Up to 93 kW (380 V – 3 phase) coming soon

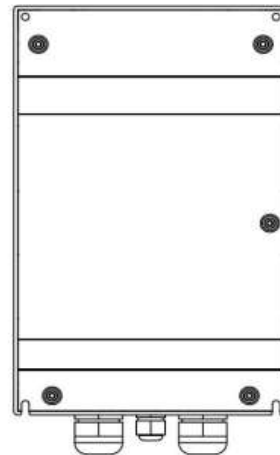
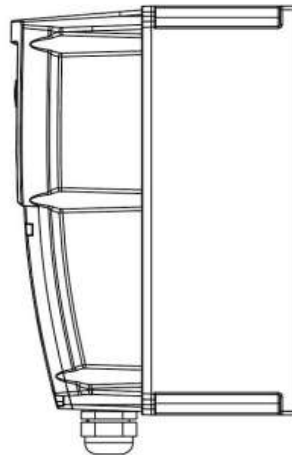
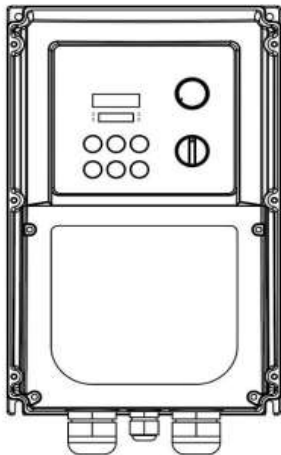

980 Exterior View

## VARIABLE SPEED DRIVE FOR SOLAR APPLICATION

# PV500 Series Solar Pump VSD

The PV500 Solar Pump Inverter (VSD) from M-Drive is a reliable and energy-efficient solution designed to power water pumps using solar energy. It efficiently converts direct current (DC) from solar panels into alternating current (AC), enabling the delivery of clean water in remote or off-grid areas.

With rising energy costs and frequent power interruptions, the PV500 offers the convenience of seamless switching between solar and municipal power supplies, ensuring uninterrupted operation. Its smart design not only reduces electricity costs but also supports sustainable, eco-friendly pumping by maximizing solar usage whenever available.



### PV500 2,2KW - 55KW 380V(-15%-30%) IP20

Part Number	Power	Output Amp	PV Input (V)	AC Input (V)	Dimensions	Dimensions
PV500-0022G3	2.2KW	5.0AMP	DC540V	380V(-15%-30%)	170x86x132	R4 092,00
PV500-0040G3	4.0KW	9.0AMP	DC540V	380V(-15%-30%)	180x96x151	R5 445,00
PV500-0055G3	5.5KW	13AMP	DC540V	380V(-15%-30%)	222x113x167	R7 524,00
PV500-0075G3	7.5KW	17AMP	DC540V	380V(-15%-30%)	222x113x167	R8 701,00
PV500-0110G3	11KW	25AMP	DC540V	380V(-15%-30%)	265x160x172	R13 167,00
PV500-0150G3	15KW	32AMP	DC540V	380V(-15%-30%)	265x160x172	R14 124,00
PV500-0220G3	22KW	45AMP	DC540V	380V(-15%-30%)	303x192x172	R18 590,00
PV500-0300G3	30KW	60AMP	DC540V	380V(-15%-30%)	349x227x172	R29 145,00
PV500-0370G3	37KW	75AMP	DC540V	380V(-15%-30%)	349x227x172	R35 445,00
PV500-0450G3	45KW	90AMP	DC540V	380V(-15%-30%)	490x328x238	R44 827,00
PV500-0550G3	55KW	110AMP	DC540V	380V(-15%-30%)	490x328x238	R53 178,00

Keep the voc of the solar panels between 540V~650V, and power output to be 1.5~2 times the power of the pump

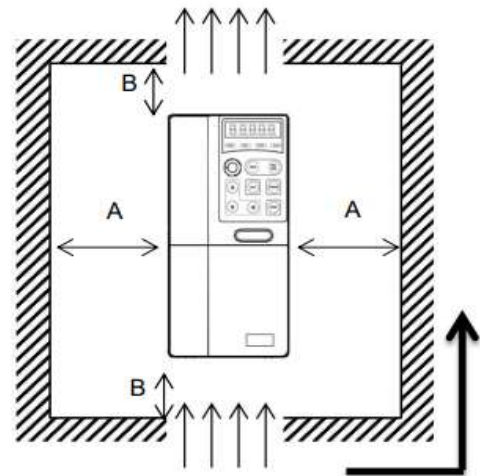
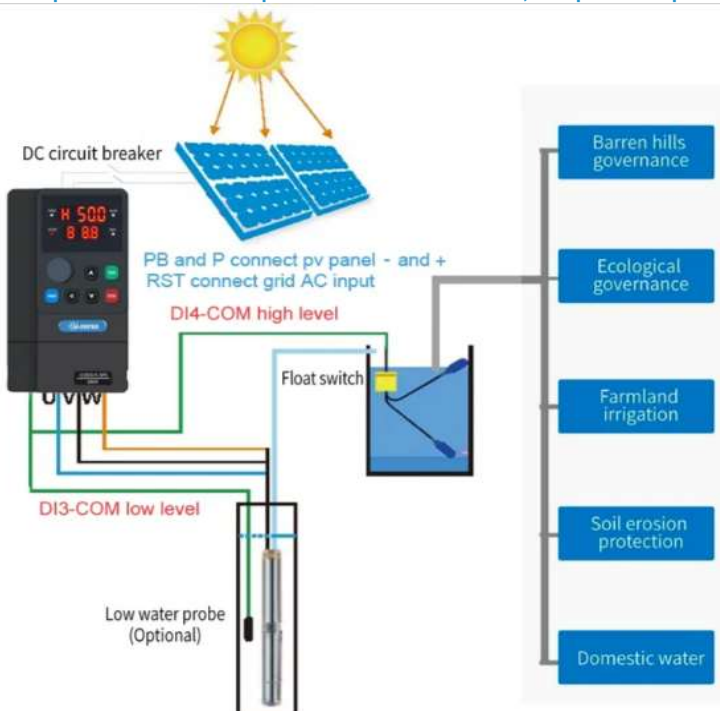

Power Class	Clearance Requirements	
18.5kW~22kW	A≥10	B≥200
30kW~37kW	A≥50	B≥200
45kW~110kW	A≥50	B≥300

## VARIABLE SPEED DRIVE, HEAVY DUTY APPLICATION

### EM760 High Performance, Closed Loop VSD

- SIL3 Level (Built-in STO Safety Torque Off Function)
- Closed-Loop and Open-Loop Control
- 3-ph AC 340V-460V 0.75kW-710kW
- 3-ph AC 525V-690V 18.5kW-800kW
- VVF/SVC/FVC Control
- LCD Digital Displays
- Support STO Function
- Modbus RTU/Profinet/EtherCAT/CANopen Communication
- Support PM/AM



### EM760 0.75KW - 400KW AC340-460V

Part Number	Power		Rated Current		Ingress Protection	Dimensions
	ND	HD	ND	HD		WxHxD
EM760-0R7G/1R5P-3B	1.5KW	0.75KW	4.2AMP	2.5AMP	IP21	95x230x171
EM760-1R5G/2R2P-3B	2,2KW	1.5KW	5.6AMP	4.2AMP	IP21	95x230x171
EM760-2R2G/3R0P-3B	3.0KW	2.2KW	7.2AMP	5.6AMP	IP21	95x230x171
EM760-4R0G/5R5P-3B	5.5KW	4.0KW	12AMP	9.4AMP	IP21	95x230x171
EM760-5R5G/7R5P-3B	7.5KW	5.5KW	17AMP	13AMP	IP21	110x275x187
EM760-7R5G/9R0P-3B	9.0KW	7.5KW	20AMP	17AMP	IP21	110x275x187
EM760-011G/015P-3B	15KW	11KW	32AMP	25AMP	IP21	140x297x207
EM760-015G/018P-3B	18.5KW	15KW	38AMP	32AMP	IP21	140x297x207
EM760-022G/030P-3B	30KW	22KW	59AMP	45AMP	IP21	190x350x220
EM760-037G/045P-3/3B	45KW	37KW	87AMP	75AMP	IP21	254x484x221
EM760-055G/075P-3/3B	75KW	55KW	145AMP	110AMP	IP21	304x548x266
EM760-090G/110P-3	110KW	90KW	208AMP	176AMP	IP21	324x635x254
EM760-132G/160P-3	160KW	132KW	298AMP	253AMP	IP21	339x621x296
EM760-200G/220P-3	220KW	200KW	410AMP	380AMP	IP21	441x1025x358
EM760-250G/280P-3	280KW	250KW	510AMP	465AMP	IP21	560x1204x404
EM760-315G/355P-3	355KW	315KW	640AMP	585AMP	IP21	660x1597x434
EM760-400G/450P-3	450KW	400KW	810AMP	725AMP	IP21	660x1597x434

The EM760 series inverter is a high-performance vector control VFD, which integrates the synchronous motor drive and asynchronous motor drive. It supports three-phase AC asynchronous motors and permanent magnet synchronous motors; drive control technologies, such as the improved vector VF control technology (VVF), speed sensorless vector control technology (SVC) and speed sensor vector control technology (FVC); speed output and torque output; Wi-Fi access and background software debugging; expansions such as I/O expansion cards, communication bus expansion cards and PG cards.

#### Features of the EM760 series inverter:

1. Standard built-in C3 filter to meet the high requirements of electromagnetic compatibility
2. Built-in DC reactor to reduce input current distortion and increase the power factor
3. Standard LCD panel, easy to operate
4. Integration of the permanent magnet synchronous motor / asynchronous motor / permanent magnet synchronous reluctance motor / high-speed motor drive
5. Mainstream bus expansion cards: PROFINET, CANopen, EtherCAT
6. PG cards: OC, differential, UVW, resolver PG card, sine and cosine PG card



## VARIABLE SPEED DRIVE, HEAVY DUTY APPLICATION

! The 525VAC series of Sinee VSDs is not currently kept ex stock,

**EM760 18.5KW - 400KW AC525-690V**

Part Number	Power		Rated Current		Ingress Protection	Dimensions
	ND	HD	ND	HD		WxHxD
EM760-018G/022P-6B	22KW	18.5KW	28AMP	25AMP	IP21	254x484x221
EM760-030G/037P-6B	37KW	30KW	42AMP	35AMP	IP21	254x484x221
EM760-045G/055P-6B	55KW	45KW	63AMP	52AMP	IP21	304x548x266
EM760-075G/090P-6B	90KW	75KW	95AMP	86AMP	IP21	324x635x264
EM760-110G/132P-6	132KW	110KW	147AMP	120AMP	IP21	339x621x296
EM760-160G/185P-6	185KW	160KW	200AMP	175AMP	IP21	422x786x335
EM760-200G/220P-6	220KW	200KW	235AMP	221AMP	IP21	422x786x335
EM760-250G/280P-6	280KW	250KW	300AMP	270AMP	IP21	441x1025x358
EM760-315G/355P-6	355KW	315KW	380AMP	330AMP	IP21	560x1204x404
EM760-400G/450P-6	450KW	400KW	540AMP	465AMP	IP21	660x1597x434



**Asynchronous Motor:** Rotor runs slightly slower than the stator field using induced current.



**Permanent Magnet Motor:** Uses built-in magnets on the rotor for efficient operation.

**Synchronous Motor:** Rotor spins in sync with the stator's magnetic field.

Contact us for a quote

[www.ironsidegroup.co.za](http://www.ironsidegroup.co.za)

# SINEE

## IP5A Fan And Pump VSD AC525V

- Open Loop, sensorless vector
- Multi motor control
- Built-in PID
- Marine type certification from DNV
- Flying start function
- Modbus RTU
- 8 Digital Inputs, 2 Analog Inputs, 1 pulse and 1 thermistor
- 4 Digital outputs, 1 relay output, 2 analog outputs



### IP5A 5.5KW - 110KW AC525-600V±10%, 110% 60s

Part Number	Power	Output Amp	Voltage	WxHxD (mm)	Protection	List Price
SV055-IP5A-6	5.5KW	9 AMP	AC525-600V	200x355x183	IP20	R26 737,00
SV075-IP5A-6	7.5KW	12 AMP	AC525-600V	200x355x183	IP20	R27 466,00
SV110-IP5A-6	11KW	17 AMP	AC525-600V	200x355x183	IP20	R31 110,00
SV150-IP5A-6	15KW	23 AMP	AC525-600V	250x385x201	IP00	R36 213,00
SV185-IP5A-6	18.5KW	27 AMP	AC525-600V	250x385x201	IP00	R39 129,00
SV220-IP5A-6	22KW	34 AMP	AC525-600V	250x385x201	IP00	R49 334,00
SV300-IP5A-6	30KW	43 AMP	AC525-600V	250x385x201	IP00	R58 810,00
SV370-IP5A-6	37KW	55 AMP	AC525-600V	300x534x293	IP00	R78 321,00
SV450-IP5A-6	45KW	64 AMP	AC525-600V	300x534x293	IP00	R83 826,00
SV550-IP5A-6	55KW	80 AMP	AC525-600V	300x534x293	IP00	R94 760,00
SV750-IP5A-6	75KW	104 AMP	AC525-600V	370x610x338	IP00	R123 917,00
SV900-IP5A-6	90KW	128 AMP	AC525-600V	370x610x338	IP00	R134 851,00
SV1100-IP5A-6	110KW	150 AMP	AC525-600V	510x784x423	IP00	R218 677,00
SV1320-IP5A-6	132KW	200 AMP	AC525-600V	510x784x423	IP00	R240 545,00
SV1600-IP5A-6	160KW	242 AMP	AC525-600V	510x784x423	IP00	R262 412,00
SV2200-IP5A-6	220KW	333 AMP	AC525-600V	TBC	IP00	R357 172,00
SV2800-IP5A-6	280KW	424 MAP	AC525-600V	TBC	IP00	R393 618,00

### IP5A 5.5KW - 280KW ACCESSORIES

Part Number	Description	List Price
SVIP5A-VF7905631	KEYPAD REMOTE INSTALLATION BRACKET FOR IP5A VSD	R165,00
SVIP5A-LCD	LCD OPERATOR FOR IP5A VSD	R2 605,00
SVIP5A-RC-2M	REMOTE CABLE FOR IP5A LCD 2-METER	R575,00
SVIP5A-RC-3M	REMOTE CABLE FOR IP5A LCD 3-METER	R740,00

#### Looking for other LS Electric VSDs?

Contact us for the full range – M100, G100, H100, S100, S300, L100, IS7, and IV5 available on request.



### EMC / RFI FILTER 380-450V 3PH

Part Number	Power	Amperage	Size	Weight	Price
AW-FIT3-2d2	2.2KW	7.0A	140/90/55.5	2.5KG	POR
AW-FIT3-004	4.0KW	8.0A	140/90/55.5	2.5KG	POR
AW-FIT3-7d5	7.5KW	16A	186/105/60	4KG	POR
AW-FIT3-011	11KW	25A	186/105/60	5KG	POR
AW-FIT3-015	15KW	30A	186/105/60	5KG	POR
AW-FIT3-018	18KW	40A	240/120/80	6KG	POR
AW-FIT3-022	22KW	45A	240/120/80	6KG	POR
AW-FIT3-030	30KW	60A	314/170/105	9KG	POR
AW-FIT3-037	37KW	75A	314/170/105	9KG	POR
AW-FIT3-045	45KW	100A	314/170/105	10KG	POR
AW-FIT3-055	55KW	120A	314/170/105	11KG	POR



### INPUT AC CHOKE 380-450V

Part Number	Power	Amperage	Size	Weight	Price
AW-RAI3-004	4	10A	130/80/138	4	POR
AW-RAI3-5d5	5.5	15A	130/80/138	4.5	POR
AW-RAI3-7d5	7.5	20A	160/100/160	5	POR
AW-RAI3-015	15	30A	160/120/165	6	POR
AW-RAI3-022	22	50A	205/125/160	9	POR
AW-RAI3-030	30	60A	205/130/146	10	POR
AW-RAI3-037	37	75A	205/135/163	11	POR
AW-RAI3-045	45	90A	205/140/164	12	POR



## VSD BRAKE RESISTORS

### CABINET RIPPLE WOUND RESISTORS

Part Number	Power	Ratings	Price
120900WCB	4kW	120 OHM 900W CABINET	POR
851200WCB	5.5 kW	85 OHM 1200W CABINET	POR
851400WCB	5.5kW	85 OHM 1400W CABINET	POR
601500WCB	7.5kW	60 OHM 1500W CABINET	POR
402000WCB	11kW	40 OHM 2000W CABINET	POR
402400WCB	11kW	40 OHM 2400W CABINET	POR
303000WCB	15kW	30 OHM 3000W CABINET	POR
324800WCB	15kW	32 OHM 4800W CABINET	POR
253000WCB	18.5kW	25 OHM 3000W CABINET	POR
204800WCB	22kW	20 OHM 4800W CABINET	POR
206000WCB	22kW	20 OHM 6000W CABINET	POR



### ALUMINIUM RESISTORS

400250W	ALUMINIUM RESISTOR 400 OHM 250W	POR
500100W	ALUMINIUM RESISTOR 500 OHM 100W	POR



**You need a brake resistor when:**

1. Fast Deceleration is Required
2. You Have a High-Inertia Load
3. You're Lifting or Lowering Loads (Gravity-Assisted Regeneration)



**What Happens Without a Brake Resistor?**

VSD overvoltage fault during braking

Drive trips or fails to stop the motor in time

## VSD BRAKE CHOPPERS

### ◆ Brake Choppers (Dynamic Brake Units) from Iron Side Electrical and Automation

Iron Side Electrical and Automation supplies a range of Z380 **brake choppers**, also known as **dynamic braking units**, **braking modules**, or **dynamic brake choppers**, designed to work seamlessly with variable speed drives (VSDs). These devices safely dissipate excess regenerative energy during motor deceleration by diverting it to an external braking resistor, helping prevent DC bus overvoltage and maintaining drive protection and performance.

Our brake choppers are reliable, compact, and ideal for high-inertia applications such as cranes, conveyors, and hoists—where rapid stopping is essential.

**Please contact us for a quotation.**

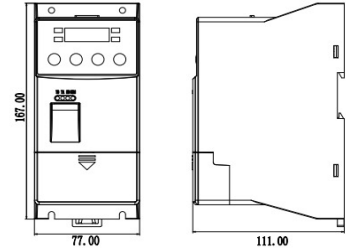

## PID PANELS COMPLETE

### ◆ PID VSD Pump Control Panel Description

We offer control panels designed for efficient and automated pump control using a built-in PID algorithm in our VSDs. Housed in a robust IP-rated steel or polycarbonate enclosure, it includes all essential components for reliable operation and protection.

Key features include a main isolator, MCB/MCCB for supply protection, and an appropriately sized VSD with analog and digital I/O for real-time feedback from a pressure or flow sensor (4-20mA / 0-10V). The panel also offers optional surge protection, contactor-based isolation, and relays or timers for pump sequencing.

User interaction is streamlined with a door-mounted keypad or pushbuttons, status indicator lights (Power ON, Running, Fault).

**Please contact us for a quotation.**



## PRESSURE TRANSDUCERS

### ANALOG PRESSURE SENSOR FOR PID

PT06420	0-6BAR	4-20mA	DC24V	R2 500,00
PT016420	0-16BAR	4-20mA	DC24V	R2 500,00



## POTENTIOMETER

### POT FOR EXTERNAL ANALOG SPEED DIAL

POT1K11	1K 3WATT, WIRE WOUND, 11.5MM	R325,00
---------	------------------------------	---------



### 💡 Did You Know?

A **1kΩ wire-wound rotary potentiometer** offers **excellent precision and durability**, making it ideal for **industrial analog controls** like speed reference dials on VSDs. Unlike carbon-track types, wire-wound pots handle **higher power and current loads**, and they don't drift as much over time.

## IE1 STANDARD EFFICIENCY CAST IRON MOTORS (MAR1)



**Construction:** Cast Iron Totally Enclosed Fan-Cooled (TEFC)  
**Application:** Heavy industrial / agriculture / mining  
**Power Supply:** Three-Phase 400V / 525V / 690V\* / 1000V\* – 50Hz & 60Hz\*\*  
**Speed:** 2, 4, 6 & 8 Pole (10, 12 & 2-speed on request)  
**Frame Size:** 80 – 500  
**Mounting:** All standard arrangements  
**Output Power:** 0.55 – 1000kW  
**IP Rating:** IP55 (increased IP ratings available: IP56 or IP65)  
**Winding:** F Class Insulation, B Class temperature rise (H Class Insulation available on request)  
**Efficiency:** IE1 Standard  
**Compliance:** SANS 1804: 1 & 2



## IE3 PREMIUM EFFICIENCY CAST IRON MOTORS (MAR3)



**Construction:** Cast Iron Totally Enclosed Fan-Cooled (TEFC)  
**Application:** Heavy industrial / premium efficiency / high specification mining  
**Power Supply:** Three-Phase 400V / 525V / 690V\* / 1000V\* – 50Hz & 60Hz\*\*  
**Speed:** 2, 4, 6 & 8 Pole  
**Frame Size:** 80 – 450  
**Mounting:** All standard arrangements  
**Output Power:** 0.55 – 1000kW  
**IP Rating:** IP66  
**Winding:** H Class insulation, B Class temperature rise  
**Efficiency:** IE3 Premium  
**Compliance:** SANS 1804: 1 & 2

### Tech Tip: What is IE3?

IE3 motors are **premium efficiency** units designed to use less energy, run cooler, and lower operating costs. They meet international standards and are ideal for industrial use where performance and energy savings matter.



## FLAME PROOF IE2 EFFICIENCY CAST IRON MOTORS (EXD)





**Construction:** Cast iron totally enclosed fan-cooled (TEFC)  
**Application:** Hazardous locations (Ex db I Mb & Ex db IIB T4 Gb)  
**Power Supply:** Three-Phase 400V / 525V / 690V\* / 1000V\* – 50Hz & 60Hz\*\*  
**Speed:** 2, 4, 6 & 8 pole  
**Frame Size:** 80 – 355  
**Mounting:** All standard arrangements  
**Output Power:** 0.55 – 315kW  
**IP Rating:** IP55  
**Winding:** F-class insulation, B-class temperature rise (H-class insulation available on request)  
**Efficiency:** IE2  
**Compliance:** SANS 60079: 0 & 1



### Need a Motor? We've Got You Covered!

From compact **single-phase motors** to powerful **3-phase and 11kV medium voltage units** — Iron Side Electrical and Automation supplies it all, including a full range of **industrial gearboxes**. Whether you're upgrading, expanding, or building from scratch, you can count on us for fast delivery and **exceptional backup service**.

 One source.  All motor types.  Zero compromise.

## FULL RANGE OF GEARBOXES AND GEARED MOTORS

**A** *Inline and single stage inline gearboxes*



**P** *Parallel and shaft mounting gearboxes*



**O** *Bevel helical gearboxes*



**RXO/700** *Universal bevel helical*



**RXO/800** *High torque bevel helical*

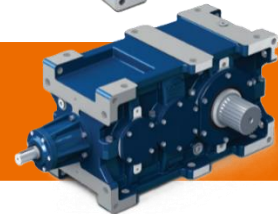

**EX** *Planetary gearboxes*



**W** *Import universal worm gearboxes*



**ZL** *Aluminium right angles*

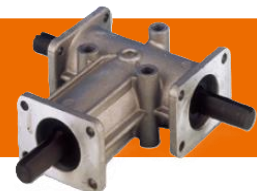

# LS ELECTRIC HMI

# HMI/PLC

## XGT PANEL, EXP2 TFT LCD HMI

Part Number	Size	Description	List Price
EXP2-0400D	4.3"	DC24V, 24BIT, WITH ETHERNET	R8 726,00
EXP2-0700D	7.0"	DC24V, 24BIT, WITH ETHERNET	R11 484,00
EXP2-1000D	10.1"	DC24V, 24BIT, WITH ETHERNET	R17 395,00

## XGT PANEL, IXP2 TFT LCD HMI

Part Number	Size	Description	List Price
IXP2-1200A	12.1"	AC100-240V, SVGA 800X600 IP66	R59 502,00
IXP2-1200D	12.1"	DC24V, SVGA 800X600 IP66	R59 503,00
IXP2-1500A	15.0"	AC100-240V, SVGA 1024X768 IP66	R72 057,00
IXP2-1500D	15.0"	DC24V, SVGA 1024X768 IP66	R72 057,00



# LS ELECTRIC PLC BLOCK TYPE

## XGB SERIES, XEM SLIM PLC

Part Number	Description	List Price
XEM-DP32H2	DC24 power supply, 16 DC24V input, 16 TR(PNP) output, Built-in Positioning Function 2 axis, Built-in Ethernet	R11 383,00
XEM-DP32HP	DC24 power supply, 16 DC24V input, 16 TR(PNP) output, Built-in Positioning Function 6 axis, Built-in Ethernet	R12 877,00



## XGB SERIES, XEC-E ECONOMIC PLC

Part Number	Description	List Price
XEC-DR14E	AC110/240V power supply, 8 DC24 in, 6 Relay out	R4 370,00
XEC-DR20E	AC110/240V power supply, 12 DC24 in, 8 Relay out	R4 963,00
XEC-DR30E	AC110/240V power supply, 18 DC24 in, 12 Relay out	R5 287,00



## XGB SERIES, XEC-SU STANDARD PLC

Part Number	Description	List Price
XEC-DR20SU	AC110/240V power supply, 12 DC24 input, 8 Relay output	R7 661,00
XEC-DR30SU	AC110/240V power supply, 18 DC24 input, 12 Relay output	R8 308,00
XEC-DR40SU	AC110/240V power supply, 24 DC24 input, 16 Relay output	R9 980,00
XEC-DR60SU	AC110/240V power supply, 32 DC24 input, 28 Relay output	R11 975,00



## XGB SERIES, XEC-U ULTIMATE PLC

Part Number	Description	List Price
XEC-DN32U	AC110/240V power supply, 16 DC24 input, 16 TR(NPN : Sink) output	R14 674,00
XEC-DP32U	AC110/240V power supply, 16 DC24 input, 16 TR(PNP : Source) output	R14 674,00
XEC-DP32UA	AC110/240V power supply, 16 DC24 input, 16 TR(PNP : Source) output, Built-in Analog	R23 360,00
XEC-DP32UP	AC110/240V power supply, 16 DC24 input, 16 TR(PNP : Source) output, Built-in Positioning Function	R20 015,00
XEC-DR28U	AC110/240V power supply, 16 DC24 input, 12 Relay output	R14 674,00
XEC-DR28UA	AC110/240V power supply, 16 DC24 input, 12 Relay output, Built-in Analog	R23 360,00
XEC-DR28UP	AC110/240V power supply, 16 DC24 input, 12 Relay output, Built-in Positioning Function	R20 015,00



## TEMPERATURE CONTROLLERS

### LED DISPLAY MULTIFUNCTION AC100-230V

Code	Size	Configuration	List Price
FT803-AR1-B	96x96	3AMP NO	R1 090,00
FT803-DR1-B	72x72	3AMP NO	R976,00
FT803-GR1-B	48x48	3AMP NO	R861,00
FT815-ANXR11NN-B	96x96	Temperature Controller	R1 130,00



### DIGITAL PID TEMPERATURE CONTROLLER

Code	Size	Configuration	List Price
TC-FT300	48x48 no/nc	Maxwell Temp Cont	R998,00
TC-MTD48	48x48 no	Maxwell Temp Cont	R1 095,00
TC-MTD49	96x48 no	Maxwell Temp Cont	R1 261,00
TC-MTD96	96x96 no	Maxwell Temp Cont	R1 470,00



### TEMPERATURE SENSOR

Code	Description	List Price
TP-PT100	Temperature Probe	R650,00
TP-PT100-H	Temperature Probe Alum	R1 465,00
TP-PT100-N	Temperature Probe Nut	R950,00
TP-TJ	Temperature Probe Type J	R625,00
TP-TK	Temperature Probe Type K	R625,00
TP-TK-H	Temperature Probe Alum	R1 465,00
TP-TK-N	Temperature Probe Nut	R850,00



## POWER SUPPLY

### SWITCHMODE POWER SUPPLY

Code	Description	List Price
NDR-120-24	DC24V,5A OUT, AC85-264V IN	R1 625,00



## CABLE TIES

### CABLE TIES, 100 PER PACKET, BLACK

Code	Description	List Price
T18R-EK	2.5MM X 120MM BLACK, CT-2.5X120	R21,00
T18I-EK	2.5MM X 150MM BLACK, CT-2.5X150	R26,00
T18L-EK	2.5MM X 160MM BLACK, CT-2.5X160	R29,00
T30R-EK	3.5MM X 300MM BLACK, CT-3.5X300	R87,00
T30L-EK	3.5MM X 400MM BLACK, CT-3.5X400	R123,00
T50R-EK	4.7MM X 200MM BLACK, CT-4.7X200	R84,00
T50I-EK	4.7MM X 300MM BLACK, CT-4.7X201	R132,00



◆ **Please take note**

Cable ties have a minimum order quantity of 10 packets per size for logistic purposes.

## JQX SLIMLINE RELAYS – WITHOUT TOGGLE

Code	Configuration	Voltage	List Price
JQX-14F-1Z-12D	1-POLE   1C/O	12VDC	R78,00
JQX-14F-1Z-24	1-POLE   1C/O	24VAC	R78,00
JQX-14F-1Z-110	1-POLE   1C/O	110VAC	R78,00
JQX-14F-1Z-220	1-POLE   1C/O	220VAC	R78,00
JQX-14F-1Z-24D	1-POLE   1C/O	24VDC	R78,00
JQX-14F-2Z-24	2-POLE   2C/O	24VAC	R86,00
JQX-14F-2Z-110	2-POLE   2C/O	110VAC	R86,00
JQX-14F-2Z-220	2-POLE   2C/O	220VAC	R86,00
JQX-14F-2Z-24D	2-POLE   2C/O	24VDC	R86,00



## JQX SLIMLINE RELAYS – WITHOUT TOGGLE

Code	Configuration	Voltage	List Price
JQX-14FT-1Z-24	1-POLE   1C/O	AC24V	POR
JQX-14FT-1Z-110	1-POLE   1C/O	AC110V	POR
JQX-14FT-1Z-220	1-POLE   1C/O	AC220V	POR
JQX-14FT-1Z-24D	1-POLE   1C/O	DC24V	POR
JQX-14FT-2Z-24	2-POLE   2C/O	AC24V	POR
JQX-14FT-2Z-110	2-POLE   2C/O	AC110V	POR
JQX-14FT-2Z-220	2-POLE   2C/O	AC220V	POR
JQX-14FT-2Z-24D	2-POLE   2C/O	DC24V	POR
JQX-FC-24D	2-POLE   2C/O	DC24V	POR
JQX-FC-220	2-POLE   2C/O	AC220V	POR



## RXML RELAY WITH INDICATION DIODE

Code	Configuration	Voltage	List Price
RXM2L-2Z-24D	2 C/O	24VDC	R97,00
RXM2L-2Z-220	2 C/O	220VAC	R97,00
RXM3L-3Z-24D	3 C/O	24VDC	R104,00
RXM3L-3Z-220	3 C/O	220VAC	R104,00
RXM4L-4Z-24D	4 C/O	24VDC	R117,00
RXM4L-4Z-220	4 C/O	220VAC	R117,00



## RXML RELAY WITH INDICATION DIODE AND TEST BUTTON

Code	Configuration	Voltage	List Price
RXM2A-2Z-24D	2 C/O	24VDC	R107,00
RXM3A-2Z-220	2 C/O	220VAC	R107,00
RXM3A-3Z-24D	3 C/O	24VDC	R114,00
RXM3A-3Z-220	3 C/O	220VAC	R114,00
RXM4A-4Z-24D	4 C/O	24VDC	R127,00



## HH5 RELAY WITH INDICATION DIODE AND TEST BUTTON –

Code	Configuration	Voltage	List Price
HH52P-LT-2Z-24	2 C/O	24VAC	R107,00
HH52P-LT-2Z-24D	2 C/O	24VDC	R107,00
HH52P-LT-2Z-110	2 C/O	110VAC	R107,00
HH52P-LT-2Z-220	2 C/O	220VAC	R107,00
HH53P-LT-3Z-24	3 C/O	24VAC	R114,00
HH53P-LT-3Z-24D	3 C/O	24VDC	R114,00
HH53P-LT-3Z-110	3 C/O	110VAC	R114,00
HH53P-LT-3Z-220	3 C/O	220VAC	R114,00
HH54P-LT-4Z-24	4 C/O	24VAC	R127,00
HH54P-LT-4Z-24D	4 C/O	24VDC	R127,00
HH54P-LT-4Z-110	4 C/O	110VAC	R127,00
HH54P-LT-4Z-220	Relay	220VAC	R127,00



## RELAY BASES

Code	Configuration	List Price
PYF-08A-E	Relay Base 2P	R51,00
PYF-11A-E	Relay Base 3P	R54,00
PYF-14A-E	Relay Base 4P	R57,00



## RELAY 60-SERIES 8-PIN

Code	Configuration	List Price
6012-24D	Relay 8 Pin 24VDC	R135,00
6012-220	Relay 8 Pin 220VAC	R135,00



## RELAY 60-SERIES 11-PIN

Code	Configuration	List Price
6013-24D	Relay 11 Pin 24VDC	R179,00
6013-220	Relay 11 Pin 220VAC	R179,00



## BASES 60-SERIES 8-PIN

Code	Configuration	List Price
PF083A-E	Relay Base 8 Pin	R49,00
PPF08-E	Relay Base 8 Pin	R81,00



## BASES 60-SERIES 11-PIN

Code	Configuration	List Price
PF113A-3	Relay Base 11 Pin	R56,00
PPF11-E	Relay Base 11 Pin	R87,00



## SOLID STATE RELAYS

Code	Configuration	List Price
YNCD-4825-24V-DC	Solid State 25A	R264,00
YNCD-4850-24V-DC	Solid State 50A	R336,00
YNCD-4880-24V-DC	Solid State 80A	R516,00
YNCA-4825-220V-AC	Solid State 25A	R372,00
YNCA-4850-220V-AC	Solid State 50A	R444,00
YNCA-4880-220V-AC	Solid State 80A	R552,00
YNC-CP	Cover Component	R22,00
UNC-I-50	Base Heat Sink	R169,00

# TIMERS

## AHC ELECTRONIC TIMER

Code	Description	List Price
AHC15-230V-16A	7-Day Timer 16A-AC1 24H AC 220V	R372,00
AHC15-230V-25A	7-Day Timer 25A-AC1 24H AC 220V	R438,00



## SUL MECHANICAL TIMER

Code	Description	List Price
SUL-180A	Timer 150h/BU 30Min AC 220V	R510,00
SUL-181H-220V-16A	Timer 16A 150h/BU 24H AC 220V	R474,00
SUL-181H-220V-20A	Timer 20A 150h/BU 24H AC 220V	R528,00



## H3CR TIMER

Code	Description	List Price
H3CR-A24V-ACDC	Timer 48x48 Time Scale 24V AC/DC 0.5s, 300h 11 Pin	R1 125,00
H3CR-A100-240V AC	Timer 48x48 Time Scale 100-220V AC 1.2, 300h 11 Pin	R1 125,00
H3CR-A824 220V-ACDC	Timer 48x48 Time Scale 24-220V AC/DC 1.25s, 300h 8 Pin	R1 125,00



## H3Y MINI TIMER

Code	Description	List Price
H3Y-4-5MIN-024V-DC	Mini Timer, 24VDC 300s	R402,00
H3Y-4-5MIN-220V-AC	Mini Timer, 220VAC 300s	R402,00



## MULTI-FUNCTIONAL MULTI-RANGE TIMERS

Code	Description	List Price
ZH-RT-1-A-1/D-24	24VDC, On Delay	R572,00
ZH-RT-1-B-1/D-24	24VDC, Interval (Relay switches for present time on energising)	R572,00
ZH-RT-1-E-1/D-24	24VDC, Relay energises ON (losing external contact)	R572,00
ZH-RT-1-F-1/D-24	24VDC, Pulse controlled interval (timing on opening of ext contact)	R572,00
ZH-RT-1-A-1/A-220	220VAC, On Delay	R572,00
ZH-RT-1-B-1/A-220	220VAC, Interval (Relay switches for present time on energising)	R572,00
ZH-RT-1-E-1/A-220	220VAC, Relay energises ON (losing external contact)	R572,00
ZH-RT-1-F-1/A-220	220VAC, Pulse controlled interval (timing on opening of ext contact)	R572,00
ZH-RT-1-M-1/D-24	24VDC, Multi-Function Multi-Range	R771,00
ZH-RT-1-M-1/A-220	220VAC, Multi-Function Multi-Range	R771,00
ZH-RT-1-M-2/AD	24 – 220VAC/DC Multi-Function Multi-Range	R1 011,00
ZH-RT-1-M-2T/AD	24 – 220VAC/DC Multi-Function Multi-Range	R1 068,00



## TIMER/RELAY BASE 60 SERIES

Code	Description	List Price
PF083A-E	Relay Base 8 Pin	R49,00
PF113A-3	Relay Base 11 Pin	R56,00
PPF08-E	Relay Base 8 Pin	R81,00
PPF11-E	Relay Base 11 Pin	R87,00



## PUSH BUTTONS, METAL CASE

### PUSH BUTON FLUSH, COMPLETE

Code	Description	List Price
XB2-BA11	White Pushbutton 1NO	R57,00
XB2-BA21	Black Pushbutton 1NO	R57,00
XB2-BA31	Green Pushbutton 1NO	R57,00
XB2-BA51	Yellow Pushbutton 1NO	R57,00
XB2-BA61	Blue Pushbutton 1NO	R57,00
XB2-BA42	Red Pushbutton 1NC	R57,00



### PUSH BUTTON FLUSH, HEAD ONLY

Code	Description	List Price
XB2-BA2	Black Pushbutton Head	R32,00
XB2-BA3	Green Pushbutton Head	R32,00
XB2-BA4	Red Pushbutton Head	R32,00

### PUSH BUTTON FLUSH, COMPETE, PRINTED

Code	Description	List Price
XB2-BA3341	White Arrow Pushbutton 1NO	R68,00
XB2-BA3351	Black Arrow Pushbutton 1NO	R68,00
XB2-BA3311	Green Start Pushbutton 1NO	R68,00
XB2-BA4342	Red Stop Pushbutton 1NO	R68,00



### IP65 PUSH BUTTON FLUSH, COMPETE

Code	Description	List Price
NBXB-BA11	White Pushbutton with Cover 1NO	R111,00
NBXB-BA21	Black Pushbutton with Cover 1NO	R111,00
NBXB-BA31	Green Pushbutton with Cover 1NO	R111,00
NBXB-BA42	Red Pushbutton with Cover 1NO	R111,00
NBXB-BA51	Yellow Pushbutton with Cover 1NO	R111,00
NBXB-BA61	Blue Pushbutton with Cover 1NO	R111,00



### IP65 PUSH BUTTON FLUSH, HEAD ONLY

Code	Description	List Price
NBXB-BA1	White Head with Cover	R76,00
NBXB-BA2	Black Head with Cover	R76,00
NBXB-BA3	Green Head with Cover	R76,00
NBXB-BA4	Red head with Cover	R76,00
NBXB-BA5	Yellow Head with Cover	R76,00
NBXB-BA6	Blue Head with Cover	R76,00



### EMERGENCY STOP COMPLETE

Code	Description	List Price
XB2-BS542	40mm Red Twist-to-Release 1NC	R110,00
XB2-BT42	40mm Red PUSH-PULL 1NC	R115,00
XB2-BS142	40mm Red Key Reset 1NC	R151,00
NP2-J174	Enclosed Emergency Stop 40mm Twist-to-Release	R232,00



### 40Ø MUSHROOM BUTTON – SELF-RESET

Code	Description	List Price
XB2-BC31	Green Spring Return 1NO	R93,00



## PUSH BUTTONS, METAL CASE

# PB/SW

### 60Ø MUSHROOM BUTTON – SELF-RESET

Code	Description	List Price
XB2-BR31	Green Spring Return 1NO	R93,00
XB2-BR42	Red Spring Return 1NC	R93,00

### DOUBLE HEADED BUTTON

Code	Description	List Price
XB2-BL8325	Double Head Pushbutton 1NO + 1NC	R76,00
XB2-BL8425	Double Head Pushbutton Raised 1NO + 1NC	R76,00

### PLASTIC PUSH BUTTON ECONOMY

Code	Description	List Price
XB2-EA125	Black Pushbutton Economy 1NO/1NC	R40,00

## ILLUMINATED PUSH BUTTONS

### ILLUMINATED BUTTON COMPLETE

Code	Description	List Price
XB2-BW3161	White LED 220v	R104,00
XB2-BW3361	Green LED 220v	R104,00
XB2-BW3561	Yellow LED 220v	R104,00
XB2-BW3661	Blue LED 220v	R104,00
XB2-BW3462	Red LED 220v	R104,00

### ILLUMINATED DOUBLE BUTTON COMPLETE

Code	Description	List Price
XB2-BW8465	Stop / Start 220v Stop Raised	R132,00
XB2-BW8365	Stop / Start 220v Level Raised	R132,00

## SELECTOR SWITCHES

### SELECTOR SWITCH ROTARY COMPLETE

Code	Description	List Price
XB2-BD21	Selector 2-Position 1NO	R87,00
XB2-BD25	Selector 2-Position 2NO	R100,00
XB2-BD83	Selector 3-Position 2NO Maintained and Spring-Return	R140,00
XB2-BD33	Selector 3-Position 2NO	R100,00

### KEY SELECTOR SWITCH COMPLETE

Code	Description	List Price
XB2-BG21	Key out 1 Pos 1NO	R117,00
XB2-BG25	Key out 1 Pos 2NO	R117,00
XB2-BG33	Key out center 2NO	R117,00
XB2-BG41	Key out 1 Pos 1NO	R117,00
XB2-BG61	Key out 1 Pos Spring Return 1NO	R117,00



## SELECTOR SWITCHES

### LED ILLUMINATED SELECTOR SWITCH

Code	Description	List Price
XB2-BK2365	LED Selector Switch 220v Green 1NO/1NC	R177.00
XB2-BK2465	LED Selector Switch 220v Red 1NO/1NC	R177.00
XB2-BK2565	LED Selector Switch 220v Yellow 1NO/1NC	R177.00
XB2-BK2665	LED Selector Switch 220v Blue 1NO/1NC	R177.00
XB2-BK2765	LED Selector Switch 220v White 1NO/1NC	R177.00
XB2-BK3375	LED Selector Switch 220v 3P Green 1NO/1NC	R177.00
XB2-BK3475	LED Selector Switch 220v 3P Red 1NO/1NC	R177.00



### ACCESSORIES AND SPARES

#### BEZELS, CONTACTS, GUARDS AND LABELS

Code	Description	List Price
XB2-BZ009	METAL BEZEL	R14,00
XB2-BE101	CONTACT BLOCK NO	R23,00
XB2-BE102	CONTACT BLOCK NC	R23,00
F03	PROTECTIVE GUARD	R57,00
XB2-WARN	WARNING LABEL	R21,00



#### 22MM ENCLOSURES

Code	Description	List Price
BOX1G	1 Hole Box Grey	R 64.00
BOX1Y	1 Hole Box Yellow	R 64.00
BOX2G	2 Hole Box Grey	R 78.00
BOX2Y	2 Hole Box Yellow	R 78.00
BOX3G	3 Hole Box Grey	R 98.00
BOX3Y	3 Hole Box Yellow	R 98.00
BOX4G	4 Hole Box Grey	R122.00
BOX5G	5 Hole Box Grey	R165.00

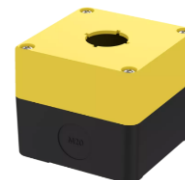

#### BA9 INCANDESCENT LAMP

Code	Description	List Price
BA9IL-24	AC/DC 24V	R15,00
BA9IL-220	AC/DC 220V	R15,00

#### BA9 NEON LAMP

Code	Description	List Price
BA9NL-24	AC/DC 24V	R12,00
BA9NL-220	AC/DC 220V	R12,00



#### BA9 LED LAMP

Code	Description	List Price
BA9LL-24R	24v AC/DC Bulbs Red	R26,00
BA9LL-24G	24v AC/DC Bulbs Green	R26,00
BA9LL-24Y	24v AC/DC Bulbs Yellow	R26,00
BA9LL-24B	24v AC/DC Bulbs Blue	R26,00
BA9LL-24W	24v AC/DC Bulbs White	R26,00
BA9LL-230R	230v AC/DC Bulbs Red	R26,00
BA9LL-230G	230v AC/DC Bulbs Green	R26,00
BA9LL-230Y	230v AC/DC Bulbs Yellow	R26,00
BA9LL-230B	230v AC/DC Bulbs Blue	R26,00
BA9LL-230W	230v AC/DC Bulbs White	R26,00



Electrical and Automation

## LED PILOT LIGHTS, INDICATORS, BUZZERS

### PILOT LIGHT 22MM LED AC/DC24V

Code	Description	List Price
AD127-22D/2(G)24V	Green LED	R41,00
AD127-22D/S(R)24V	Red LED	R41,00
AD127-22D/S(Y)24V	Yellow LED	R41,00
AD127-22D/S(B)24V	Blue LED	R41,00
AD127-22D/S(W)24V	White LED	R41,00
AD127-22D/S(O)24V	Orange LED	R41,00



### PILOT LIGHT 22MM LED AC/DC110V

Code	Description	List Price
AD127-22D/S(G)110V	Green LED	R41,00
AD127-22D/S(R)110V	Red LED	R41,00
AD127-22D/S(Y)110V	Yellow LED	R41,00
AD127-22D/S(B)110V	Blue LED	R41,00
AD127-22D/S(W)110V	White LED	R41,00
AD127-22D/S(O)110V	Orange LED	R41,00



### PILOT LIGHT 22MM LED AC/DC230V

Code	Description	List Price
AD127-22D/S(G)230V	Green LED	R41,00
AD127-22D/S(R)230V	Red LED	R41,00
AD127-22D/S(Y)230V	Yellow LED	R41,00
AD127-22D/S(B)230V	Blue LED	R41,00
AD127-22D/S(W)230V	White LED	R41,00
AD127-22D/S(O)230V	Orange LED	R41,00



### PILOT LIGHT 22MM LED AC/DC380V

Code	Description	List Price
AD127-22D/S(G)380V	Green LED	R41,00
AD127-22D/S(R)380V	Red LED	R41,00
AD127-22D/S(Y)380V	Yellow LED	R41,00
AD127-22D/S(B)380V	Blue LED	R41,00
AD127-22D/S(W)380V	White LED	R41,00
AD127-22D/S(O)380V	Orange LED	R41,00



### 22MM BUZZER

Code	Description	List Price
NFM1-22/F S24V	24V AC/DC Buzzer	R102,00
NFM1-22F S230V	230VAC Buzzer	R102,00



## SIGNAL TOWERS

### CPT BASE

Code	Description	List Price
CPT-7-BNS-3W-24V	3 Wires 24VDC Base No Sound	R192,00
CPT-7-BNS-3W-220V	3 Wires 220VAC Base No Sound	R192,00
CPT-7-BWS-5W-24V	5 Wires 24VDC Base with Sound	R410,00
CPT-7-BWS-5W-220V	5 Wires 220VAC Base with Sound	R410,00



## Electrical and Automation SIGNAL TOWERS

### CPT STACKABLE HOUSING DC24V

Code	Description	List Price
CPT-7-RLH-24V	Red LED Housing 24VDC	R441,00
CPT-7-GLH-24V	Green LED Housing 24VDC	R441,00
CPT-7-OLH-24V	Orange LED Housing 24VDC	R441,00
CPT-7-BLH-24V	Blue LED Housing 24VDC	R441,00
CPT-7-WLH-24V	White LED Housing 24VDC	R441,00

### CPT STACKABLE HOUSING AC220V

Code	Description	List Price
CPT-7-RLH-220V	Red LED Housing 220VAC	R441,00
CPT-7-GLH-220V	Green LED Housing 220VAC	R441,00
CPT-7-OLH-220V	Orange LED Housing 220VAC	R441,00
CPT-7-BLH-220V	Blue LED Housing 220VAC	R441,00
CPT-7-WLH-220V	White LED Housing 220VAC	R441,00



### CPT TOP COVERS

Code	Description	List Price
CPT-COVER	TOP COVER	R40,00

## TNHA PENDANT CONTROL STATIONS

### PENDANT CONTROLS (SINGLE DEPRESS, 1 SPEED)

Code	Description	List Price
TNHA1-61C	2-WAY 1NO+1NC, C/W E-STOP	AC250/500V R457,00
TNHA1-62C	4-WAY 1NO+1NC, C/W E-STOP	AC250/500V R592,00
TNHA1-63C	6-WAY 1NO+1NC, C/W E-STOP	AC250/500V R768,00
TNHA1-64C	8-WAY 1NO+1NC, C/W E-STOP	AC250/500V R936,00
TNHA1-65C	10-WAY 1NO+1NC, C/W E-STOP	AC250/500V R1 260,00

Current Rating AC-15, 380v - 2A, 230v -3,5A

### PENDANT CONTROLS (DOUBLE DEPRESS, 2SPEED)

Code	Description	List Price
TNHA1-61CS	2-WAY 2NO, C/W E-STOP	AC250/500V R760,00
TNHA1-62CS	4-WAY 2NO, C/W E-STOP	AC250/500V R1 008,00
TNHA1-63CS	6-WAY 2NO, C/W E-STOP	AC250/500V R1 539,00
TNHA1-64CS	8-WAY 2NO, C/W E-STOP	AC250/500V R1 780,00
TNHA1-65CS	10-WAY 2NO, C/W E-STOP	AC250/500V R2 592,00

Current Rating AC-15, 380v - 2A, 230v -3,5A

#### ◆ Pendant Control – Description & Use

A **pendant control** is a handheld device used to remotely operate machinery or equipment from a safe and convenient distance. It typically features pushbuttons, selector switches, or joysticks mounted in an ergonomic housing, allowing the operator to control movement, start/stop functions, or directional commands. Pendant controls are commonly used with **overhead cranes, hoists, gantries, conveyors, and automated machinery**, where direct access to the equipment is limited or unsafe. They provide flexibility, improve safety, and allow precise manual control during setup, maintenance, or positioning tasks.



## DISTRIBUTION BOARDS & ENCLOSURES

### DB4 SURFACE MOUNT PVC

EKDB4P9RST	9 Way Distribution Board	200x219x108	R489,00
EKDB4P12RST	12 Way Distribution Board	215x273x118	R595,00
EKDB4P18RST	18 Way Distribution Board	215x381x118	R922,00
EKDB4P24RST	24 Way Distribution Board	365x273x118	R1 070,00



### DB8 METAL ENCLOSURE IP55 ORANGE

DB8-3025/20-O	300x250x200	1.2mm Body 2mm Chassis	R1 350,00
DB8-4030/20-O	400x300x200	1.2mm Body 2mm Chassis	R1 805,00
DB8-4030/25-O	400x300x250	1.2mm Body 2mm Chassis	R1 805,00
DB8-5040/20-O	500x400x200	1.2mm Body 2mm Chassis	R2 880,00
DB8-5040/25-O	500x400x250	1.2mm Body 2mm Chassis	R2 880,00
DB8-6040-25-O	600x400x250	1.2mm Body 2mm Chassis	R3 590,00
DB8-6040/30-O	600x400x300	1.2mm Body 2mm Chassis	R3 771,00
DB8-7050-20-O	700x500x200	1.2mm Body 2mm Chassis	R5 055,00
DB8-7050/25-O	700x500x250	1.2mm Body 2mm Chassis	R5 055,00
DB8-7060/30-O	700x600x300	1.5mm Body 2mm Chassis	R5 055,00
DB8-8060/30-O	800x600x300	1.5mm Body 2mm Chassis	R6 720,00
DB8-10080/30-O	1000x800x300	1.5mm Body 2mm Chassis	R9 930,00
DB8-10080/40-O	1000x800x400	1.5mm Body 2mm Chassis	R9 930,00
DB8-120100/30-O	1200x1000x300	1.5mm Body 2mm Chassis	R12 145,00
DB8-120100/40-O	1200x1000x400	1.5mm Body 2mm Chassis	R12 160,00



### DB8 METAL ENCLOSURE IP55 GREY

DB8-3025/20-G	300x250x200	1.2mm Body 2mm Chassis	R1 350,00
DB8-4030/25-G	400x300x250	1.2mm Body 2mm Chassis	R1 805,00
DB8-5040/25-G	500x400x250	1.2mm Body 2mm Chassis	R2 880,00
DB8-6040-25-G	600x400x250	1.2mm Body 2mm Chassis	R3 590,00
DB8-6040/20-G	600x400x200	1.2mm Body 2mm Chassis	R3 590,00
DB8-8060/30-G	800x600x300	1.5mm Body 2mm Chassis	R6 720,00
DB8-10080/30-G	1000x800x300	1.5mm Body 2mm Chassis	R9 930,00
DB8-120100/30-G	1200x1000x300	1.5mm Body 2mm Chassis	R12 145,00

◆ **Please note.**  
Pricing on DB8 steel enclosures is for reference purpose only and depends on stock availability. Please check-in with us for availability before



## MERLIN SYSTEMS ENCLOSURES

### M250 SINGLE DOOR ENCLOSURES IP55

Part Number	Height x Width x Depth (mm)	Material Thickness	Net Price
M-250-44-SD	400x400x250	1.6mm	R2 382,00
M-250-46-SD	600x400x250	1.6mm	R2 766,00
M-250-48-SD	800x400x250	1.6mm	R3 128,00
M-250-410-SD	1000x400x250	1.6mm	R3 799,00
M-250-412-SD	1200x400x250	1.6mm	R4 183,00
M-250-64-SD	400x600x250	1.6mm	R2 911,00
M-250-66-SD	600x600x250	1.6mm	R3 231,00
M-250-68-SD	800x600x250	1.6mm	R3 811,00
M-250-610-SD	1000x600x250	1.6mm	R4 637,00
M-250-612-SD	1200x600x250	1.6mm	R5 124,00
M-250-84-SD	400x800x250	1.6mm	R3 411,00
M-250-86-SD	600x800x250	1.6mm	R4 052,00
M-250-88-SD	800x800x250	1.6mm	R4 591,00
M-250-810-SD	1000x800x250	1.6mm	R5 481,00
M-250-812-SD	1200x800x250	1.6mm	R6 072,00



### M250 VSD ENCLOSURES WITH LOUVERS IP3X

Part Number	Height x Width x Depth (mm)	Material Thickness	List Price
M-250-44-VSD	400x400x250	1.6mm	R2 587,00
M-250-46-VSD	600x400x250	1.6mm	R2 981,00
M-250-48-VSD	800x400x250	1.6mm	R3 332,00
M-250-410-VSD	1000x400x250	1.6mm	R4 004,00
M-250-412-VSD	1200x400x250	1.6mm	R4 387,00
M-250-64-VSD	400x600x250	1.6mm	R3 116,00
M-250-66-VSD	600x600x250	1.6mm	R3 603,00
M-250-68-VSD	800x600x250	1.6mm	R4 051,00
M-250-610-VSD	1000x600x250	1.6mm	R4 956,00
M-250-612-VSD	1200x600x250	1.6mm	R5 445,00
M-250-84-VSD	400x800x250	1.6mm	R3 684,00
M-250-86-VSD	600x800x250	1.6mm	R4 275,00
M-250-88-VSD	800x800x250	1.6mm	R4 864,00
M-250-810-VSD	1000x800x250	1.6mm	R5 875,00
M-250-812-VSD	1200x800x250	1.6mm	R6 424,00



**◆ Please note.**

Merlin System's enclosure comes with powder coated body and door, aluminium zinc chassis and gland plates. Galvanized mounting brackets. Other options available includes glass doors, inner-doors and complete custom enclosure design. Contact us for more information.



## FANS AND ACCESSORIES

### FANS WITH BEARINGS AC230V

Code	Description	List Price
DS8025ABNL	230v Fan with Bearings 80mm	R253.00
DS9225ABNL	230v Fan with Bearings 90mm	R253.00
DS12038ABNL	230v Fan with Bearings 120mm	R210.00
DS15052ABNL	230v Fan with Bearings 150mm	R462.00



### FAN FILTERS

Code	Description	List Price
ZL-801	Fan Filter 106 x 106 x 10	R144.00
ZL-802	Fan Filter 116 x 116 x 10	R180.00
ZL-803	Fan Filter 148 x 148 x 13,5	R288.00
ZL-150	Fan Filter 148 x 148 x 13,5	R288.00
ZL-205	Fan Filter 205 x 205 x 13,5	R336.00
ZL-256	Fan Filter 256 x 256 x 13,5	R396.00
ZL-320	Fan Filter 320 x 320 x 13,5	R456.00



### VENTILATION KIT

Code	Description	List Price
FB-9801	Round Ventilation Kit	R354,00
FB-9802	Round Ventilation Kit	R354,00
FB-9801B	Rain Resistant Hood	R336,00
FB-9802B	Rain Resistant Hood	R336,00
RECSMAL	Rectangle Small 329x115x13.5	R270,00
RECBIG	Rectangle Big	R330,00
PB-9801	Ventilation Kit	R270,00



### VENTILATION KIT

Code	Description	List Price
FG-80	Metal Guard 80mm	R12,00
FG-92	Metal Guard 92mm	R14,00
FG-120	Metal Guard 120mm	R16,00
FG-150	Metal Guard 159mm	R21,00
FG-200	Metal Guard 200mm	R36,00
FG-250	Metal Guard 250mm	R60,00
FG-300	Metal Guard 300mm	R84,00

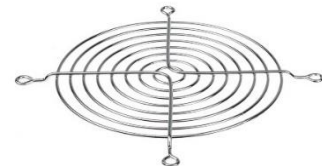

#### Tech Tip: Using Panel Fans for Effective Cooling

Ensure proper airflow by pairing your panel fan with a filtered air inlet and positioning it for cross-ventilation. Clean filters regularly to prevent dust buildup and maintain cooling efficiency.

# FOOT SWITCHES



## XF FOOT SWITCHES

XF-1	Foot Switch	Steel	R143,00
XF-1D	Foot Switch	Steel	R778,00
XF-302	Foot Switch	Aluminium	R578,00
XF-4	Foot Switch	Aluminium	R219,00
XF-402	Foot Switch	Aluminium	R492,00
XF-502	Foot Switch	Aluminium	R894,00
XF-89	Foot Switch	Aluminium	R1 788,00
XF502S	Foot Switch	Aluminium	R1 198,00
XF-86	Foot Switch	Aluminium	R1 095,00
XF87	Foot Switch	Aluminium	R1 545,00
XF91	Foot Switch	Plastic	R261,00

 **Tech Tip: Installing Foot Switches for Industrial Use**  
 Always mount foot switches on a stable, non-slip surface and ensure they are positioned within easy reach to reduce operator fatigue. Use models with protective guards to prevent accidental activation in high-traffic

## MICRO SWITCHES

### MINATURE - SNAP ACTION 15A 250V

Code	Description	List Price
CS10N-001-C2	Standard Plunger	R30,00
CS10N-021-C2	Medium Plain Lever	R30,00
CS10N-011-C2	Short Plain Lever	R30,00
CS10N-041-C2	Simulated Roller Lever	R30,00
CS10N-031-C2	Long Plain Lever	R30,00
CS10N-061-C2	Long Roller Lever	R30,00
CS10N-051-C2	Short Roller Lever	R30,00



### MINATURE - SNAP ACTION 15A 250V

Code	Description	List Price
CM-1300	Pin Plunger	R98,00
CM-1301	Pin with Med Lever	R100,00
CM-1303	Pin with Long Roller Lever	R104,00
CM-1306	Button Plunger	R90,00
CM-1307	EXT (Panel Mount) Plunger	R130,00
CM-1308	EXT (Panel Mount) Roller Plunger	R145,00
CM-1309	EXT (Panel Mount) Roller Plunger 90	R150,00
CM-1305	EXT Plunger	R120,00
CM-1318	Horizontal Roller Plunger	R120,00
CM-1701	Long Plain Lever	R90,00
CM-1702	Short Plain Lever	R35,00
CM-1703	Long Roller Lever	R100,00
CM-1704	Short Roller Lever	R95,00
CM-1743	Short (Collapsible) Roller Lever	R110,00
CM-1705	Long Wire Lever	R115,00
CM-CAP	CM Series Cap Y Cover for CM Terminals	R26,00
CMR-302-1	Joy Stick Control 4 Way	R579,00



### MINATURE - SNAP ACTION 15A 250V

Code	Description	List Price
CZ-7120	Long Lever	R150,00
CZ-7121	Long Lever with Roller	R140,00
CZ-7140	Short Lever	R150,00
CZ-7141	Short Lever with Roller	R140,00
CZ-7310	Button plunger	R170,00
CZ-7311	EXT Panel Mount Roller Plunger	R200,00
CZ-7312	EXT Panel Mount Roller Plunger 90°	R200,00



### TOGGLE SWITCH

Code	Description	List Price
C511B	Single Pole ON/OFF	R50,00
C512B	Single Pole ON/ON	R50,00
C513B	Single Pole - Double Throw Centre Off	R65,00
C521B	Double Pole ON/OFF	R60,00
C522B	Double Pole ON/ON	R60,00
C523B	Double Pole Double Throw Centre Off	R70,00
RAIN CAP	Rubber Boot	R25,00



## MICRO SWITCHES

### IW METAL BODY SERIES 44x40x23 IP64

Code	Description	List Price
LXJW2/11/HL	Limit Switch Direct Drive	R220,00
LXJW2/11/HG	Top Plunger Roller Lever	R220,00
LX-X2	Plastic Switch Direct Drive	R36,00

### LIMIT SWITCHES PLASTIC BODY SERIES 60x30x32 IP64

#### CLS METAL ROLLER TYPE

Code	Description	List Price
CLS-101	Top Plunger	R125,00
CLS-103	Top Roller Plunger	R145,00
CLS-111	Top Plunger Roller Lever	R152,00
CLS-121	Rotating Roller Lever	R152,00
CLS-127	Top Plunger Roller Lever (Offset)	R152,00
CLS-131	Rotating Roller Lever (adjustable)	R152,00
CLS-181	Omni - Directional Wobble Spring	R225,00
CLS-191	Rotating Roller Lever Adjustable Large Wheel	R189,00
CLS-103R	Top Roller Plunger - Manual Reset	R240,00



### ME & TZ 8000 METAL BODY SERIES 65x29x25 IP64

#### Double Action 1NO/1NC 10A - Plastic Roller Type

Code	Description	List Price
LXME8104	Rotating Roller Lever	R289,00
LXME8108	Rotating Roller Lever (Adjustable)	R270,00
LXME8166	Omni - Directional Wobble Spring	R220,00



#### Double Action 1NO/1NC 10A - Metal Roller Type

Code	Description	List Price
TZ-8104	Rotating Roller Lever	R220,00
TZ-8108	Rotating Roller Lever (Adjustable)	R240,00
TZ-8167	Omni - Directional Wobble Spring	R230,00
TZ-8107	Rotating Rod Lever (Adjustable)	R250,00
TZ-8111	Pin Plunger	R200,00
TZ-8112	Roller Plunger	R230,00
TZ-8122	Roller Plunger 90°	R230,00
TZ-8166	Cats Whisker	R240,00



### K3 METAL BODY SERIES 72x42x36

#### Double Action 1NO/1NC 10A - Metal Roller Type

Code	Description	List Price
LX-K3/20S/Z	Top Plunger	R360,00
LX-K3/20S/L	Top Roller Plunger	R360,00
LX-K3/20S/B	Rotating Roller Lever	R360,00
LX-K3/20S/T	Rotating Roller Lever (Adjustable)	R360,00
LX-K3/20S/D	Omni - Directional Wobble Spring - Plastic Cap	R360,00
LX-K3/20S/W	Cats Whisker	R360,00
LX-K3/20S/J	Rotating Rod Lever	R360,00
LX-K3/20S/H1	Dual Roller Arm - Latching 2 Metal Front R	R420,00
LX-K3/20H/T	Rotating Roller Lever ADJ	R474,00



All pricing excludes VAT

## P1 METAL BODY SERIES 72X42X36

### DOUBLE ACTION PLASTIC ROLLER TYPE

Code	Description	List Price
LXP1/120/1E	Limit Switch Direct Drive	R276,00
LXP1/120/1F	Top Plunger Roller Lever (Offset)	R288,00
LX-K1/K	Switch Component – 1NO/1NC	R81,00

## CSA – METAL BODY SERIES 62X52X25 IP65

### METAL ROLLER TYPE

Code	Description	List Price
CSA-001	Top Plunger	R432,00
CSA-012	Top Plunger Roller Lever	R462,00
CSA-021	Rotating Roller Lever	R462,00
CSA-003	Top Roller Plunger	R432,00
CSA-031	Rotating Roller Lever Adjustable	R462,00
CSA-081	Omni-Directional Wobble Spring	R462,00

## CZ SAFETY LIMIT – 61X31X30 IP65

### METAL TYPE

Code	Description	List Price
CZ93-K1	Straight Key	R112,00
CZ93-K2	Angled Key	R112,00
CZ93-K3	Straight Key “T” Type (Insulated)	R150,00
CZ93-CPG	Safety Limit – Key Type 1NO/1NC	R402,00
CZ93-BPG	Safety Limit – Key Type 2NC	R402,00



### PULLCORD LIMIT

Code	Description	List Price
YBLX-KLT2-11	Limit Pullcord H/D 250x250mm Dual End	R3 276,00

### PLASTIC BODY

Code	Description	List Price
LX-CK/P121	Top Plunger Plastic Roller	R133,00
LX-CK/S102	Top Plunger Metal Roller	R164,00

#### Did you know?

Limit switches were first developed in the **early 1900s** to improve **elevator safety**, automatically stopping the lift at the right floor and preventing over-travel. While there's no single credited inventor, companies like **Elevator Companies** pioneered their use. These switches soon became essential in factories, laying the foundation for **modern industrial automation** — turning mechanical movement into electrical signals long before PLCs existed!

# PROXIMITY SENSORS

## INDUCTIVE PROXIMITY, 8mm DIA, IP67

Part Number	Voltage	Configuration	Mounting	Connection	Price
CJY08E-02NA	DC10-30V	3-WIRE NPN NO	NON-FLUSH	CABLE	R410,00
CJY08E-02NB	DC10-30V	3-WIRE NPN NC	NON-FLUSH	CABLE	R410,00
CJY08E-02PA	DC10-30V	3-WIRE -NPN NO	NON-FLUSH	CABLE	R410,00
CJY08E-02PB	DC10-30V	3 WIRE PNP NC	NON-FLUSH	CABLE	R410,00

## INDUCTIVE PROXIMITY, 12mm DIA, IP67

CJY12E-02PC	DC10-30V	4 WIRE PNP NO + NC	FLUSH	CABLE	R530,00
CJY12E-02PC-T	DC10-30V	4 WIRE PNP NO + NC	FLUSH	M12 PLUG	R530,00
CJY12E-02PC-T	DC10-30V	3 WIRE PNP NO	NON-FLUSH	M12 PLUG	R530,00
CJY12E-04PB	DC10-30V	3 WIRE PNP NC	NON-FLUSH	CABLE	R530,00
CJY12E-04PC	DC10-30V	4 WIRE PNP NO + NC	NON-FLUSH	CABLE	R530,00
CJY12E-04KA	AC90-250V	2 WIRE NO	NON-FLUSH	CABLE	R530,00
CJY12E-04NC-T	DC10-30V	4 WIRE NPN NO+NC	NON-FLUSH	M12 PLUG	R530,00
CJY12E-04PA-T	DC10-30V	3 WIRE PNP NO	NON-FLUSH	M12 PLUG	R530,00
CJY12E-04PB-T	DC10-30V	3 WIRE PNP NC	NON-FLUSH	M12 PLUG	R530,00
CJY12E-04PC-T	DC10-30V	4 WIRE PNP NC+NO	NON-FLUSH	M12 PLUG	R530,00

## INDUCTIVE PROXIMITY, 18mm DIA, IP67

CJY18E-05PC	DC10-30V	4 WIRE PNP NO+NC	FLUSH	CABLE	R670,00
CJY18E-05PC-T	DC10-30V	4 WIRE PNP NO + NC	FLUSH	M12 PLUG	R670,00
CJY18E-05NC	DC10-30V	4 WIRE NPN-NC	FLUSH	CABLE	R670,00
CJY18E-08PA	DC10-30V	3 WIRE PP-NO/NC	NON FLUSH	CABLE	R670,00
CJY18E-08PC	DC10-30V	3 WIRE PNP – NO/NC	NON FLUSH	CABLE	R670,00
CJY18E-08PC-T	DC10-30V	4 WIRE PNP NO+NC	NON FLUSH	M12 PLUG	R670,00
CJY18E-08NC	DC10-30V	3 WIRE NPN NC	NON FLUSH	CABLE	R670,00
CJY18E-08NC-T	DC10-30V	4 WIRE NPN NC	NON FLUSH	M12 PLUG	R670,00

## INDUCTIVE PROXIMITY, 30mm DIA, IP67

CJY30E-10PC	DC10-30V	4 WIRE PNP NO/NC	NON-FLUSH	CABLE	R780,00
CJY30E-10PC-T	DC10-30V	4 WIRE PNP NO/NC	NON-FLUSH	M12 PLUG	R780,00
CJY30E-15PC	DC10-30V	4 WIRE PNP NO/NC	NON-FLUSH	CABLE	R780,00
CJY30E-15PC-T	DC10-30V	4 WIRE PNP NO/NC	NON-FLUSH	M12 PLUG	R780,00

## INDUCTIVE PROXIMITY, SQUARE, IP67

CJF17-05PA	DC10-30V	3 WIRE PNP NO	17mm2	CABLE	R340,00
CJF18-05PA	DC10-30V	3 WIRE PNP NO	18mm2	CABLE	R390,00
CJF25-07PA	DC10-30V	3 WIRE PNP NO	25mm2	CABLE	R430,00

## CAPACITIVE PROXIMITY, 12mm DIA, IP65

CRY12-05PC	DC10-30V	4 WIRE PNP NO/NC	FLUSH	CABLE	R1 110,00
CRY12-05PC-T	DC10-30V	4 WIRE PNP NO/NC	FLUSH	M12 PLUG	R1 110,00

## CAPACITIVE PROXIMITY, 18mm DIA, IP65

CRY18-05PC	DC10-30V	4 WIRE PNP NO/NC	FLUSH	CABLE	R1 430,00
CRY18-05PC-T	DC10-30V	4 WIRE PNP NO/NC	FLUSH	M12 PLUG	R1 430,00

## CAPACITIVE PROXIMITY, 30mm DIA, IP65

CRY30-05PC	DC10-30V	4 WIRE PNP NO/NC	FLUSH	CABLE	R1 710,00
CRY30-05PC-T	DC10-30V	4 WIRE PNP NO/NC	FLUSH	M12 PLUG	R1 710,00

## RETROREFLECTIVE PROXIMITY, 18mm DIA, IP65

CGY18E-R-2MPC	DC10-30V	4 WIRE PNP NO/NC			R1 350,00
CGY18E-R-2MPC-T	DC10-30V	4 WIRE PNP NO/NC			R1 350,00

## DIFFUSED PROXIMITY, 18mm DIA, IP65

CGY18E-D-2MPC	DC10-30V	4 WIRE PNP NO/NC			R1 410,00
CGY18E-D-2MPC-T	DC10-30V	4 WIRE PNP NO/NC			R1 410,00

## PROXIMITY CABLES

CABLE05M	5MTR CABLE	R146,00
CABLE10M	10MTR CABLE	R225,00



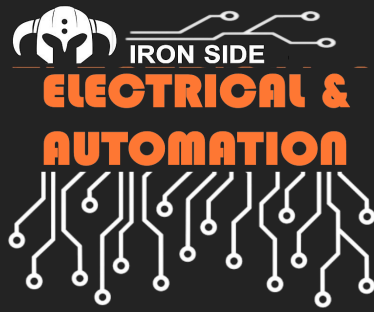

**Tel: 071 449 9412 | 079 697 8082**

**E-mail: [sales@ironsidegroup.co.za](mailto:sales@ironsidegroup.co.za)**

**E-mail: [financial@ironsidegroup.co.za](mailto:financial@ironsidegroup.co.za)**

**[www.ironsidegroup.co.za](http://www.ironsidegroup.co.za)**

**9a Albite Street, Dersley, Springs Gauteng 1559**

**© COPYRIGHT 2025**